

MFH PLANNING

MODULAR. FLOOR HEATING. 20 mm.

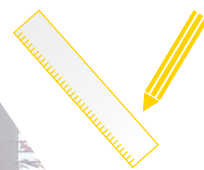

68 W/m²
35/30 °C

VarioComp.

TABLE OF CONTENTS

1	PRINCIPLES	4
1.1	Comfort	4
1.2	Energy savings	5
1.3	Description and advantages of the VarioComp floor heating	6
2	COMPONENTS	8
2.1	Overview	8
2.2	VarioProFile pipe 11.6x1.5 Laser	10
3	FLOOR STRUCTURE	11
3.1	General.....	11
3.2	Prerequisites as a suitable substructure	11
3.3	VarioComp on an existing subsurface	12
3.4	VarioComp on dry construction with load distribution layer.....	12
3.5	VarioComp on an existing subsurface + Insulation	13
3.6	Impact sound insulation	13
4	MOVEMENT JOINTS	14
5	THERMAL OUTPUT	15
5.1	Calculating the heating load.....	15
5.2	Variotherm dimensioning software	15
5.3	Heat output tables	16
6	PIPING.....	19
7	PRESSURE LOSS	20
8	FLOOR COVERING	22
8.1	General.....	22
8.2	Residual humidity of the VarioComp filling compound.....	22
8.3	Borders between VarioComp panels and blank panels (at bonding of floor coverings)	23
8.4	Levelling out with a calcium sulphate floor levelling compound	23
8.5	Compound sealing in rooms exposed to high humidity	24
8.6	Stone and ceramic coverings	25
8.7	Linoleum, carpet, PVC floor covering and synthetic resin floors	25
8.8	Wood covering, parquet and laminate.....	26

1 PRINCIPLES

That the ancient Romans already appreciated the qualities of floor and wall heating systems is proven by extensive finds and reconstructions of Roman thermal baths from the 1st century BC.

In the last 20 years, the popularity of floor heating systems has seen a substantial revival. The Variotherm floor heating system gives off radiant, long-wavelength infrared heat. Consistent with the body's own heat, similar to the heat of the sun, this type of heat is experienced as particularly pleasant.

The Variotherm floor heating system is ideal for all 'cold' floor coverings. It is an optimum temperature regulator, creating a pleasant atmosphere. Naturally, it can be used with all other floor coverings suitable for floor heating systems.

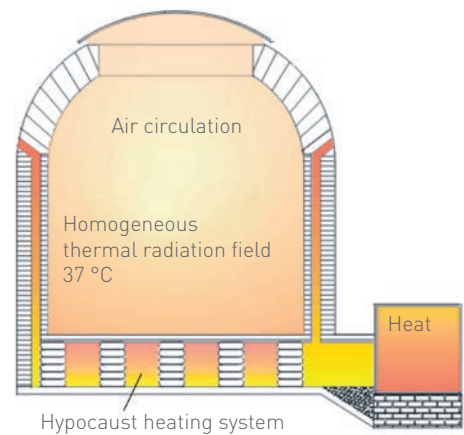

1.1 Comfort

Comfort is not only created through a certain air temperature in the room. The temperature of the surfaces enclosing the room is of equal importance. The felt temperature is roughly consistent with the arithmetic mean of both temperatures.

What makes people feel comfortable?

People feel comfortable when the following basic 'thermal comfort' equation holds:

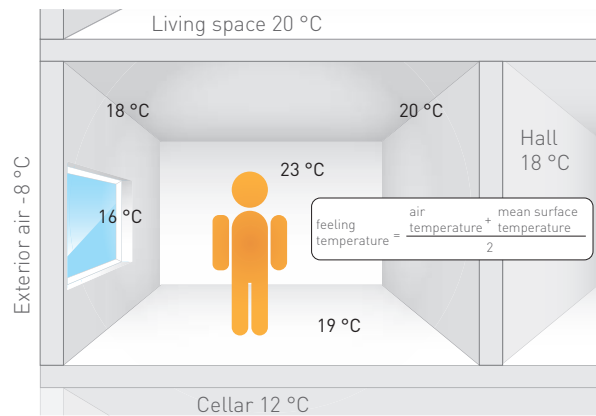

▲ Impact of the room on felt temperature

Heat production = heat loss

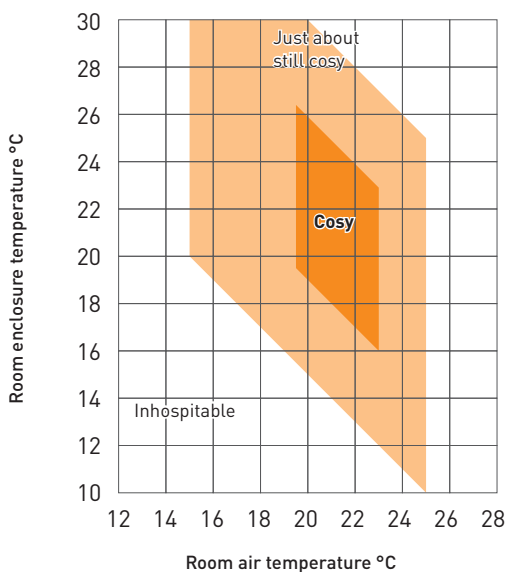

▲ Zone of cosiness

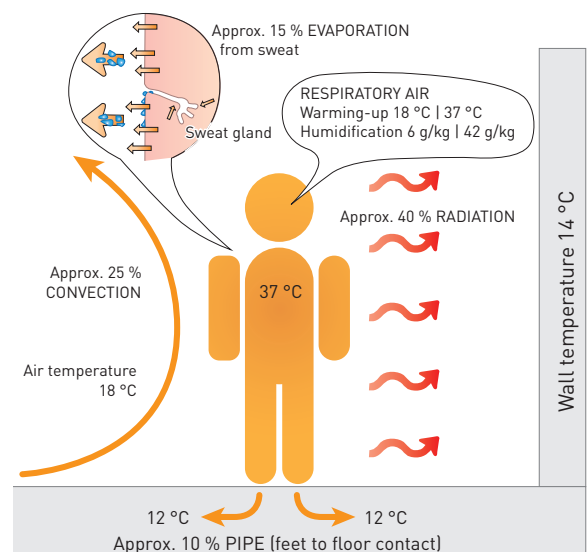

▲ Human heat balance

In this context, it is important that the heat loss from the human body is as evenly distributed in all directions as possible. We feel uncomfortable if too much heat is lost in one particular direction (cold surfaces, draughts) or heat loss is prevented in one direction (hot surfaces or steam-tight, thick clothing). In many cases it is therefore recommendable to install a combination involving the Variotherm wall heating system. Consistent heat transfer ensures that temperature layering in the room is kept at a minimum, promoting the general spreading of a pleasant temperature. In the case of floor heating, the floor is indeed warmer than the air at head-level. Indeed, according to popular wisdom, people 'stay healthy with a cool head and warm feet'. The room temperature can be set lower than with conventional heating systems. Radiant heat raises the felt air temperature without affecting your comfort.

Since the heat is transferred invisibly via the floor, no visible components have to be planned for, such as recesses for heating devices, radiators and pipes. These almost unavoidable 'subtenants' in expensive living space require a lot of room and are not pleasing to the eye. They restrict both the wall and window design and the space where furniture can be positioned.

Combined floor heating and wall heating systems complement each other perfectly in living spaces. They allow for tailor-made heat supply in every room.

1.2 Energy savings

The right floor heating system not only gives you optimum comfort, it also saves energy and money. The cost of operating a floor heating system can be reduced due to low surface temperatures and hence low heating water temperatures. Floor heating is therefore ideal where low-temperature energy sources are used, such as condensing boilers, heat pumps and solar collectors.

The approximate cost savings per 1 K (°C) lower room air temperature are 6 %. Low room air temperature also has the great physiological advantage of significantly increasing the absorption of oxygen.

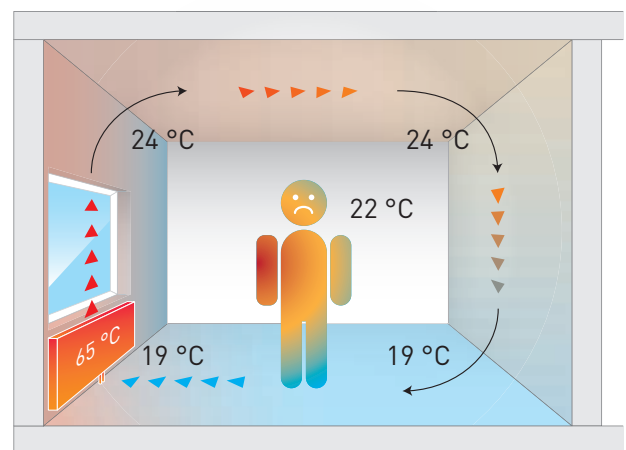

▲ Discomfort with radiators

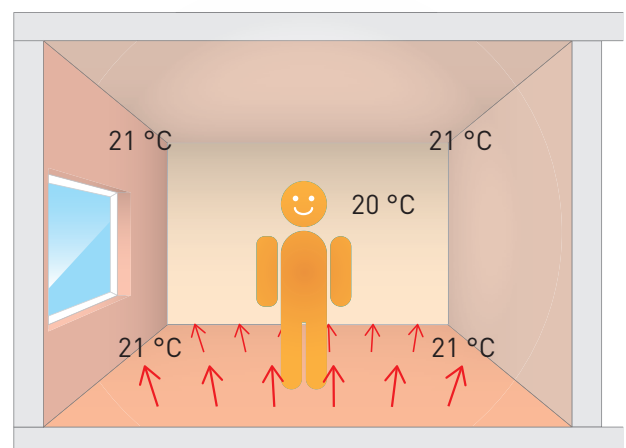

▲ Comfort with floor heating system

1.3 Description and advantages of the VarioComp floor heating

The VarioComp floor heating is ideally suited for retrofitting a floor heating system.

All components of the complete system are perfectly matched:

- The specially milled routings of the VarioComp panel
- The easy to bend VarioProFile pipe with an extremely stable form
- The ideal height for the optional XPS insulation panel
- The fast-drying VarioComp filling compound

All this makes for the perfect combination – right down to the smallest detail.

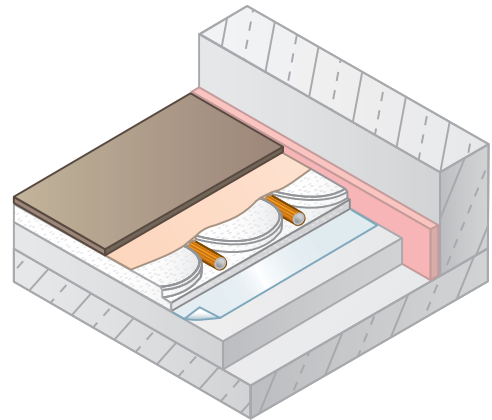

The fast reaction time allows good control of the room temperature even in sunny rooms. The complete system has been checked, tried out in practice and has been awarded with a number of quality certificates.



- 1 Floor covering
- 2 VarioComp floor heating
- 3 Construction foil
- 4 Subsurface

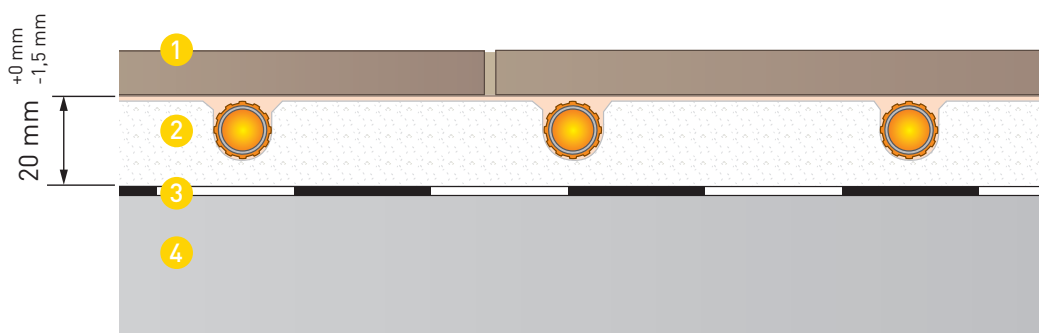

The advantages:

- System is only 20 mm high (+ 0 mm; -1.5 mm)
- Low weight of only 25 kg/m²
- Surface ready for laying the floor covering
- Fast installation, e.g. tiles can be laid after only 24 hours
- Ideal for renovations
- Continuous nap system allows free laying of pipes
- Fast reaction times:

The VarioComp floor heating was subjected to comparison measurements with a screed floor heating system (VarioRoll, pipe spacing: 100 mm, screed covering of the VarioProFile pipe: 40 mm) for 24 hours.

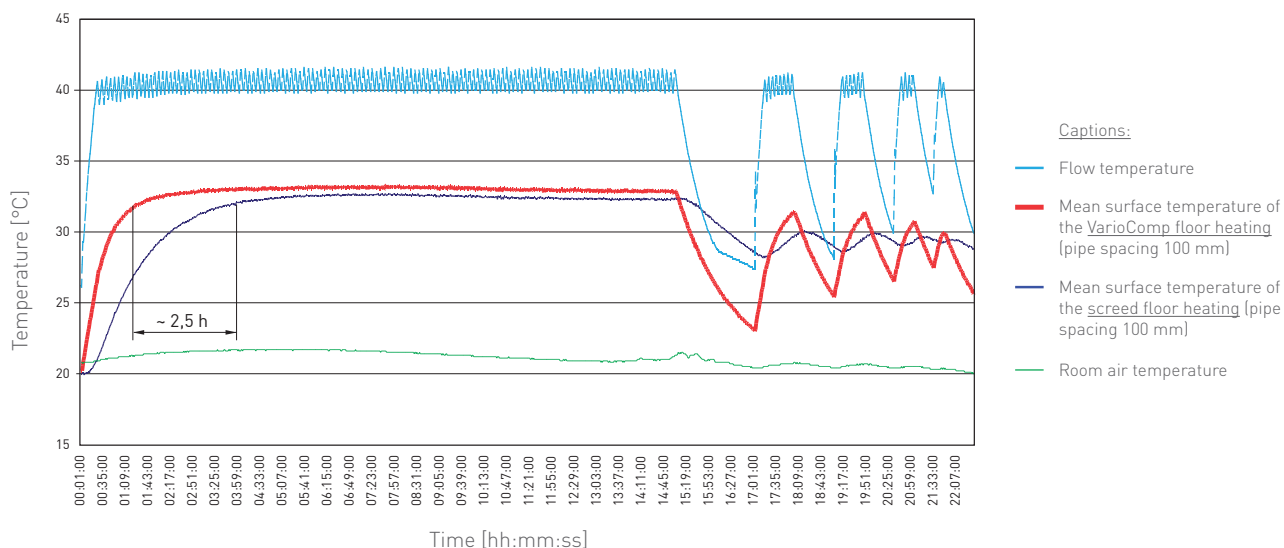

The faster heating of the surface of the VarioComp floor heating compared to the screed floor heating system can be clearly seen. The reaction time of the surface temperatures to reduced flow temperature is shorter. This results in:

- Better control of the VarioComp floor heating. The surface temperature during heating is greater than that of the screed floor heating system.
- More efficient layout of the heating surfaces because lower flow temperatures than those used for other floor heating systems are possible.

2 COMPONENTS

2.1 Overview

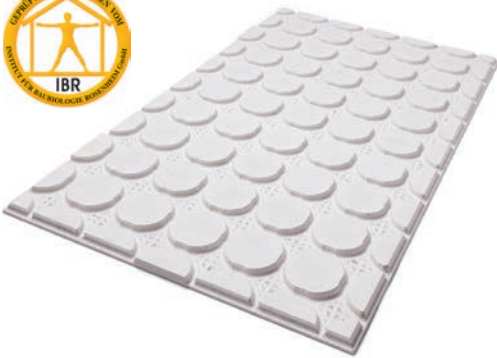
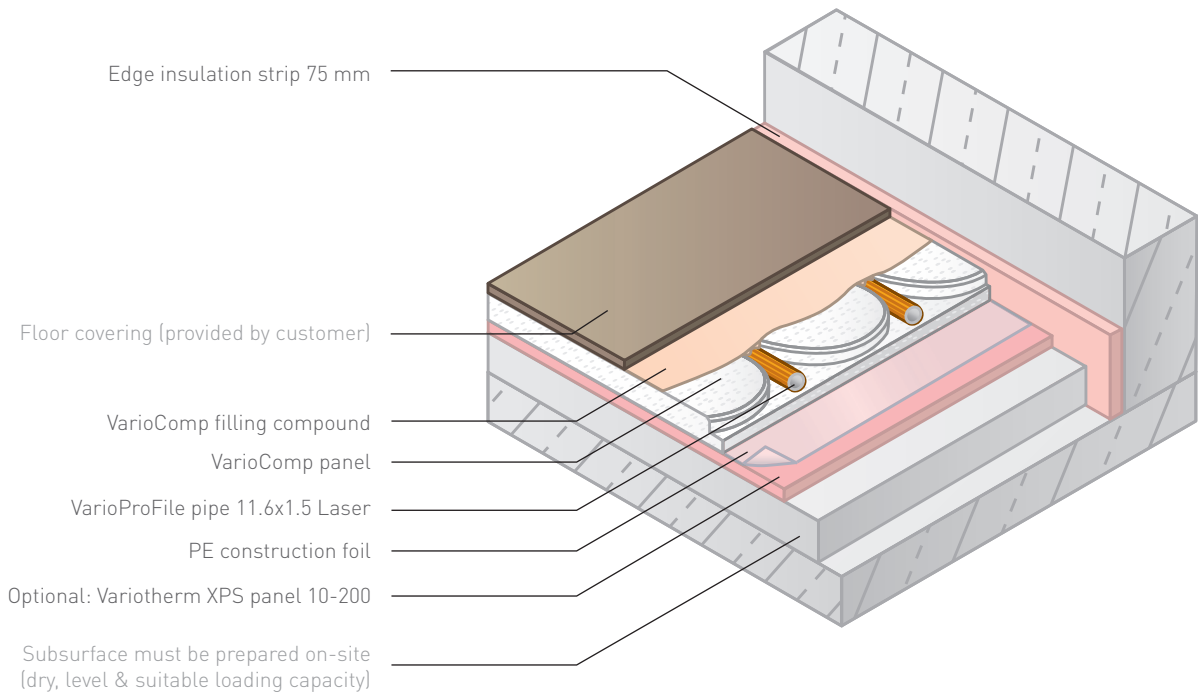

VarioComp panel

The VarioComp panel is an 18 mm thick gypsum fibreboard which has been tested for their healthy building properties. It serves as a pipe bracket and heat conducting panel for pipe spacings of 100 mm and 200 mm. It has pre-cut grooves that make it easy to lay the pipe.

Panel dimensions (w x l): 600 x 1000 mm = 0.6 m²

VarioComp filling compound

The VarioComp filling compound T7 is a special filling compound for filling the pre-laid VarioComp panels with inserted VarioProFile pipe 11.6x1.5 Laser.

The completed surface corresponds to a gypsum structure surface as per ÖN B 2207 or DIN 18352.

VarioComp filling compound is supplied on pallets in sacks weighing 25 kg. Ensure dry storage in shrink wrap until processing.

Maximum storage time is 12 months.

Consumption: approx. 6 kg/m².



VarioProFile pipe 11.6x1.5 Laser

Profiled surface structure guarantees optimum heat transfer.

For details see chapter 2.2.



Edge insulation strip 75 mm

made of PE foam, front side with self-adhesive, welded overlapping foil for the sealed connection of edge insulation strips and PE construction foil, rear side with butyl rubber adhesive strips.

As per EN 1264-4.



PE construction foil

for laying under the VarioComp panel, transparent recycled material, 0.1 mm thick



XPS panel 10-200 (optional)

for use as a thermal insulation panel directly beneath VarioComp panel. Panel thickness only 10 mm, compressive strength at 10 % compression: 200 kPa (20t/m²), thermal conductivity: 0,035 W/mK, impact sound improvement: 14 dB (tested on 140 mm reinforced concrete floor - MFPA Leipzig).

Panel dimensions (w x l): 600 x 1250 mm = 0.75 m²



Bucket set

consisting of:

- Water bucket for perfect dosage
- 30 litre bucket for mixing the VarioComp filling compound



VarioComp mixing tool

the perfect mixing tool for mixing the VarioComp filling compound.

Diameter 120 mm, required power for drive 1000 W, 600 min⁻¹, min. drill chuck 13 mm



And much more ...

The range is rounded off by the adhesive tape, the scraper, the blank panels to compensate for free remaining unheated areas, the heating/cooling distribution manifold and the correspondingly calibrated room thermostats.

2.2 VarioProFile pipe 11.6x1.5 Laser

Advantages

- Fully corrosion-free
- As light as a plastic pipe
- 10-year guarantee with certificate
- Optimum behaviour under long-term stress
- Profiled surface structure guarantees optimum heat transfer
- Flexible, easy to bend, extremely good hydrostatic stability
- Resistant to hot water additives (inhibitors, antifreeze)
- Mirror-smooth inner surface – less pressure loss – no encrustation
- High pressure and temperature resistance (10 bar, +95 °C)
- 100% oxygen diffusion-tight
- Lower linear coefficient of expansion, lower heat expansion forces
- Tested as per EN 21003, SKZ A 397

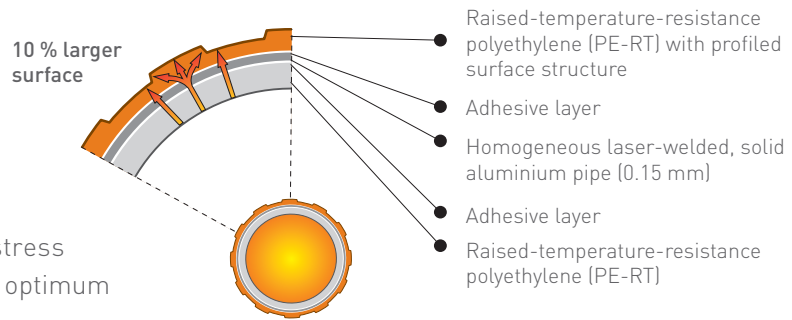

Elongation

with 10 m and temperature difference Δt 25 °C (e.g. 20 °C to 45 °C):

	Tubing	Elongation
Plastics	PEX (VPE)	50,00 mm
	PP	42,50 mm
	PB	32,50 mm
	PVC	20,00 mm
	VarioProFile pipe	5,75 mm
Metall	Cu	4,20 mm
	Stainless steel	3,50 mm
	Steel	2,88 mm

Homogeneous plastic pipes produce high stress levels in the device because of their expansion coefficient.

The VarioProFile pipe combines the minor elongation and thermal expansion. So it is perfect for surface heating- and -cooling pipes.

Technical data

Pipe diameter:	11.6 mm
Pipe wall thickness:	1.5 mm
Aluminium pipe thickness:	0.15 mm
Roll length:	100/300/500 m
Water content:	0.058 l/m
Special narrow bending radius (use a suitable bending device):	30 mm
Max. operating temperature:	$t_{max} = 95 \text{ °C}$
Short-term resistant:	$t_{mat} = 110 \text{ °C}$
Max. operating pressure:	$p_{max} = 10 \text{ bar}$
Linear expansion coefficient:	$2.3 \times 10^{-5} \text{ [K}^{-1}\text{]}$
Mean heat conduction coefficient:	$\lambda = 0.43 \text{ W/mK}$
Heat transmission resistance:	$R_{\lambda} = 0.0033 \text{ m}^2\text{K/W}$

Creep behaviour

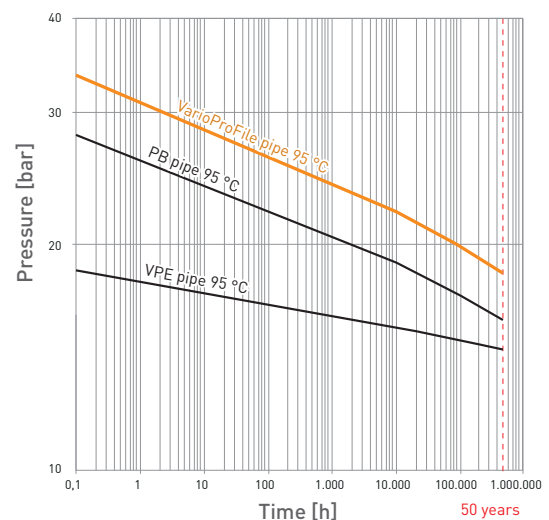

3 FLOOR STRUCTURE

3.1 General

The VarioComp panel is purely a pipe bracket and thermal conduction element. The necessary static support, heat and impact sound insulation and protection against moisture diffusion must already be provided by the construction underneath the VarioComp panel

The following items must be coordinated between the architect, construction manager, installation technician and floor layer:

- Horizontal level line
- Floor structure with Strength appropriate to the level of use, necessary vapour retarders/barriers, necessary thermal insulation/impact sound insulation and expansion joints
- VarioComp filling compound to be applied by installer, floor layer or construction manager
- Floor covering, with heat sensors if necessary

3.2 Prerequisites as a suitable substructure

The substructure must be checked by the planner for suitability! Furthermore, coordination should take place between all trades involved regarding the overall progress of construction work, including follow-up work.

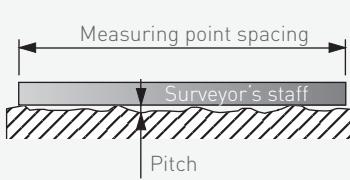
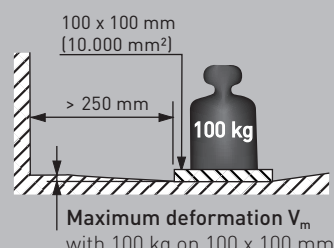
1. DRY	2. LEVEL	3. LOAD-BEARING																
<p>The subsurface must be dry, dust-free and grease-free. Maximum residual humidity of the subsurface (CM values):</p> <ul style="list-style-type: none"> • Untreated concrete: 3.0 % • Cement screed: 2.0 % • Calcium sulphate screed: 0.5 % 	<p>The required evenness is as follows (ÖNORM DIN 18202):</p> 	<p>Calculation of load-bearing capacity:</p> 																
<table border="1" style="margin: auto;"> <thead> <tr> <th colspan="4" style="background-color: #FFD700;">Measuring point spacing</th> </tr> <tr> <th style="background-color: #FFD700;">0.1 m</th> <th style="background-color: #FFD700;">1 m</th> <th style="background-color: #FFD700;">4 m</th> <th style="background-color: #FFD700;">10 m</th> </tr> </thead> <tbody> <tr> <td style="background-color: #FFD700;">1 mm</td> <td style="background-color: #FFD700;">3 mm</td> <td style="background-color: #FFD700;">9 mm</td> <td style="background-color: #FFD700;">12 mm</td> </tr> <tr> <td colspan="4" style="background-color: #FFD700;">Max. pitch</td> </tr> </tbody> </table>	Measuring point spacing				0.1 m	1 m	4 m	10 m	1 mm	3 mm	9 mm	12 mm	Max. pitch					
Measuring point spacing																		
0.1 m	1 m	4 m	10 m															
1 mm	3 mm	9 mm	12 mm															
Max. pitch																		

The load-bearing capacity specified in the table below must be provided. If there are several concentrated loads, these must be at least 500 mm apart.

Caution: The sum of the concentrated loads must not exceed the maximum permissible floor load capacity. Particularly heavy objects (pianos, aquariums, bathtubs) must be given special consideration!

Room usage examples in accordance with ÖNORM EN 1991-1-1 ÖNORM EN 1991-1-1	Max. concentrated load Q_k	Max. service load q_k	Max. deformation V_m (with 100 kg on 100 x 100 mm)
Category A1: Floors of rooms in residential buildings and houses, wards and hospital rooms (without heavy diagnostic instruments), rooms in hotels and lodgings, kitchens, toilets and rooms with residential-type use in existing buildings Category B1: Office floors in existing buildings	2.0 kN	2.0 kN/m ²	1.5 mm
Category B2: Office floors in office buildings Category C1: Floors in rooms with tables etc., e.g. classrooms in schools, cafés, restaurants, food halls, reading rooms, reception rooms, wards and hospital rooms (with heavy diagnostic instruments)	3.0 kN	3.0 kN/m ²	1.0 mm
Category C2: Floors in rooms with fixed seating, e.g. in churches, theatres, cinemas, conference rooms, lecture halls, meeting halls, waiting rooms, train station waiting rooms	4.0 kN	4.0 kN/m ²	(Floor structure on request)

3.3 VarioComp on an existing subsurface

Subsurface must be dry, level and of suitable loading capacity (see chapter 3.2)

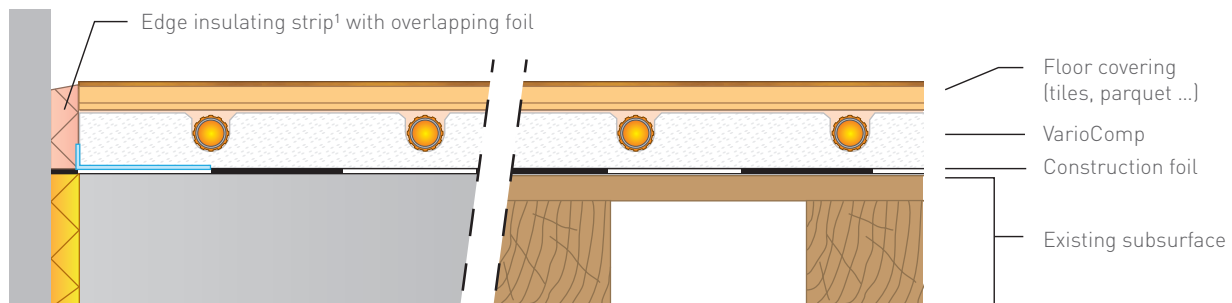

Screed:

- Test for evenness, and if necessary, even out using levelling compound.
- Test for dryness.

Bare slab:

- Test for evenness, and if necessary, even out using levelling compound.
- Building sealant, if required.

Wooden beam ceiling:

- Check bending, surface evenness and load-bearing capacity (see e.g. max. deformation V_m , Chapter 3.2); reinforce construction if required

3.4 VarioComp on dry construction with load distribution layer

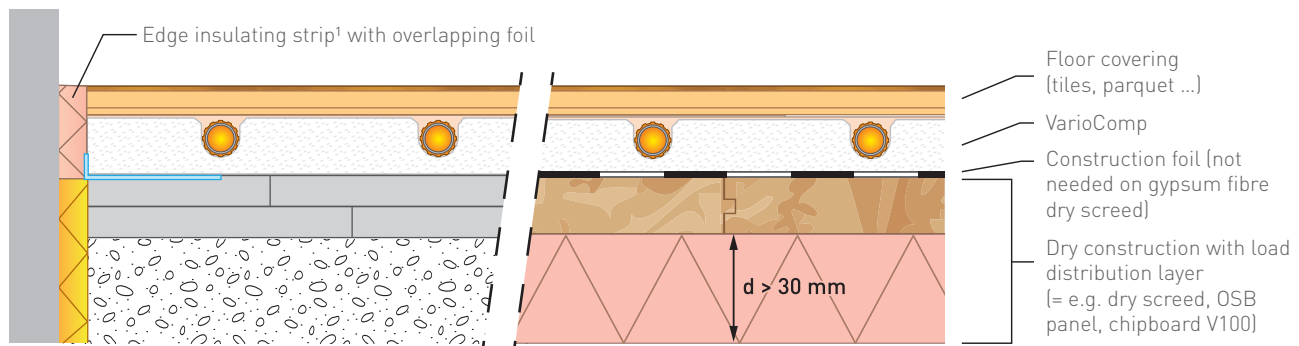

Fill

- Loose fill (note required compaction)
- Bonded fill (dry pipe density 350 kg/m^3 , compression strength $0.4 - 0.5 \text{ N/mm}^2$)
- Trickle protection sheet, if required

Load distribution layer necessary, e.g.:

- 20 mm dry screed element, processing according to manufacturer's instructions
- 2 x 15 mm OSB panel, adhered and screwed
- 2 x 19 mm chipboard (V100), adhered and screwed

Thermal insulation/impact sound insulation:

Insulation $d > 30 \text{ mm}$ or compressive strength $< 200 \text{ kPa}$ (20 t/m^2) with 10 % compression

Load distribution layer necessary, e.g.:

- 18 mm OSB panel, tongue and groove bonded
- 19 mm chipboard (V100), tongue and groove bonded
- 25 mm dry screed element, processing according to manufacturer's instructions
- 2 x 15 mm OSB panel, adhered and screwed
- 2 x 19 mm chipboard (V100), adhered and screwed

¹ Edge insulating strips are to be applied along the exterior walls, including columns, steps, door frames, pillars and shafts. They prevent sound and thermal bridges and allow the VarioComp floor heating to expand.

3.5 VarioComp on an existing subsurface + Insulation

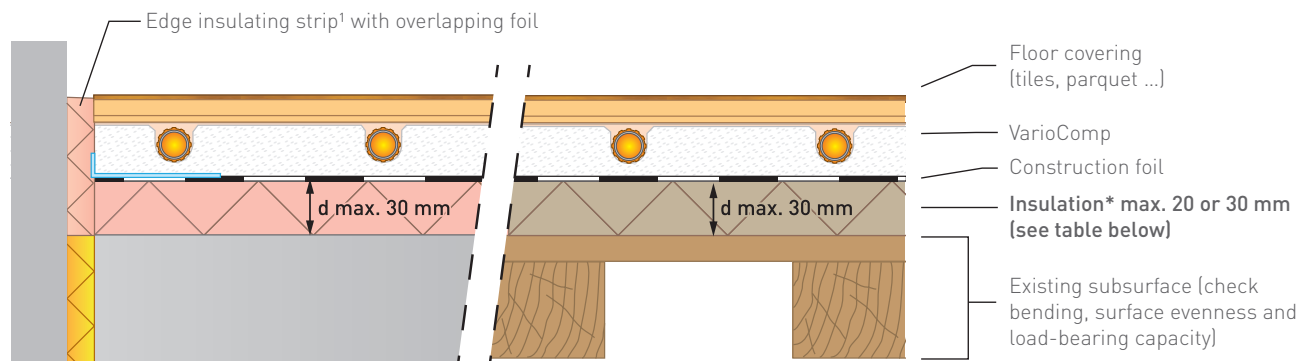

Thermal/impact sound insulation up to 20 mm:
Minimum compressive strength 200 kPa (20 t/m²) with 10 % compression

Thermal/impact sound insulation up to 30 mm:
Minimum compressive strength 300 kPa (30 t/m²) with 10 % compression

Product examples for thermal/impact sound insulation panels see table:

* Panels with insulation d max. 20 mm, compression strength minimum 200 kPa (20 t/m ²) with 10 % compression (room usage A1/B1 (see table chapter 3.2))	* Panels with insulation d max. 30 mm, compression strength minimum 300 kPa (30 t/m ²) with 10 % compression (room usage A1/B1 + B2/C1 (see table chapter 3.2))
Insulation panels and base panels	
Styrodur 2800C Austrotherm Universalplatte / Uniplatte DOW Styrofoam LB-A/LBH-X/RTM-NC-X, Floormate 200-A Unifloor Jumpax CP/Heat-Pak Jackon Jackodur CFR 300 Variotherm XPS-Platte 10-200 (10 mm)	Styrodur 3035CS Austrotherm XPS Top 30 Foamglas T4+ DOW Floormate 500-A, Styrofoam LB-A/LBH-X/RTM-NC-X Kingspan Styrozone H 350 R Jackon Jackodur CFR 300 Unifloor Jumpax CP/Heat-Pak
XPS panels with plastered weave on both sides	
Wedi Bauplatte Jackon Jackoboard PCI (BASF) Pucidur	Wedi Bauplatte Jackon Jackoboard PCI (BASF) Pucidur
Wood fibreboards	
Steico Universal/Underfloor Pavatex Isolair L22 Gutex Multiplex-top	-
Impact-sound insulation panels	
Ceresit/Cimsec CL58 Multiverlegeplatte Murexin Unitop Ardex DS 40 PCI (BASF) Polysilent Unifloor Heat-Foil/Redupax/Redupax+ Variotherm XPS-Platte 10-200, (Trittschallverbesserung 14 dB, gemessen auf 140 mm Stahlbeton-Rohdecke, MFPA Leipzig)	Ceresit/Cimsec CL58 Multiverlegeplatte PCI (BASF) Polysilent Unifloor Redupax+

3.6 Impact sound insulation

Particular attention should be paid to impact sound insulation. The impact sound improvement values should be determined by the planner or architect. The impact sound insulation must be matched to the corresponding floor structure as per Section 3. Materials that may be laid directly underneath the VarioComp floor heating to improve the impact sound insulation, see table chapter 3.5.

¹ Edge insulating strips are to be applied along the exterior walls, including columns, steps, door frames, pillars and shafts. They prevent sound and thermal bridges and allow the VarioComp floor heating to expand.

4 MOVEMENT JOINTS

Movement joints (e.g. with edge insulation strips) are attached to provide tension-free accommodation of length alterations. These are to be defined by the architect or planner.

- Max. section size 80 m², max. edge length 12 m
- Keep the number of pipe feed-throughs through the movement joints as small as possible

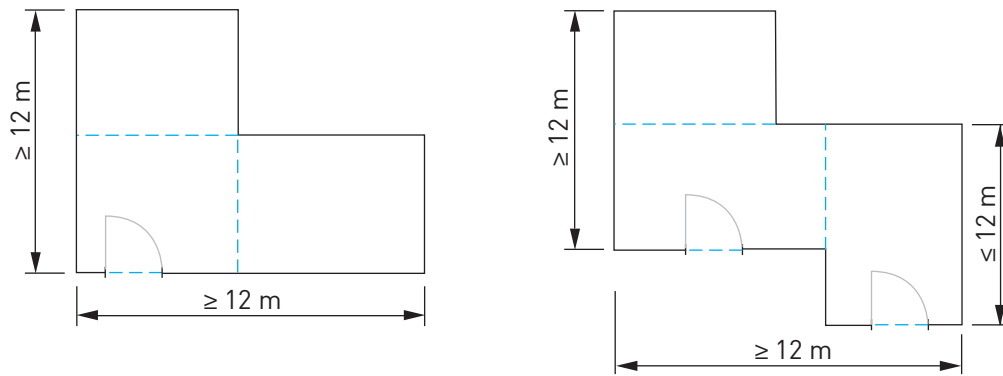

The movement joints are particularly significant in the case of ceramic coverings. It is crucial that the movement joints run congruently in all layers (VarioComp floor heating and floor covering).

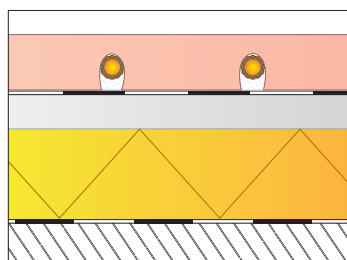
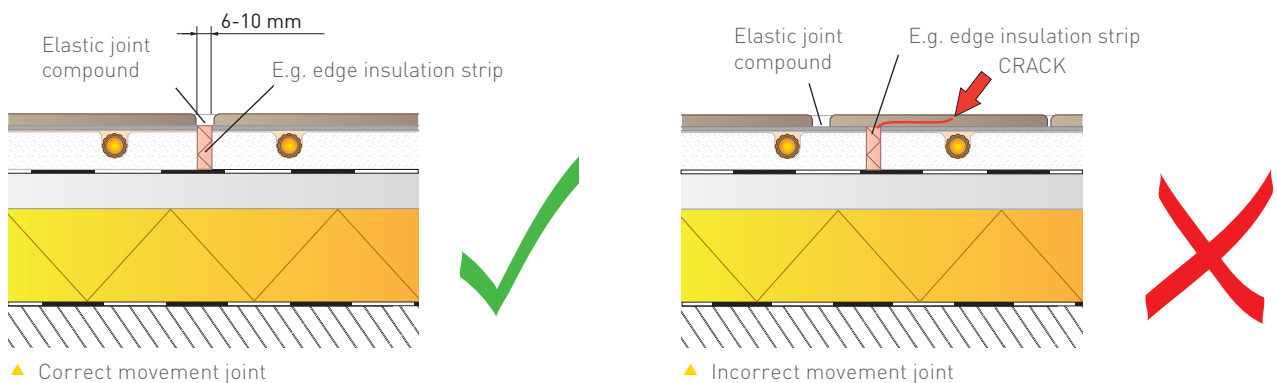

▲ Pipe feed-through through the movement joint (no sleeve tube required)

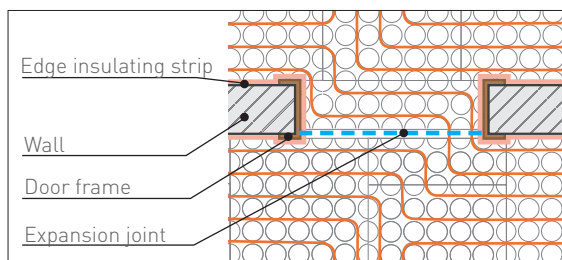

▲ In the vicinity of the door, the expansion joint is fed through under the door leaf.
Variant 1: Door area fitted with VarioComp panel

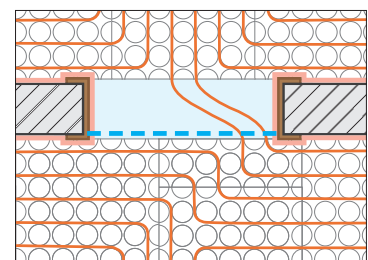

▲ Variant 2: Later, only use VarioComp filling compound to fill in the door area.

5 THERMAL OUTPUT

5.1 Calculating the heating load

Along with the respective national annex, the EN 12831 standard will be used to calculate the heating load for the heated rooms.

Every room is considered individually. For the outside temperature, the locally acquired and standardised outdoor temperature $T_{e,s}$ is used.

Übersicht der Bauteile

Code	Bezeichnung	U-Wert W/m²K	Rges m²K/W	Rsi m²K/W	Rse m²K/W	R-Baut m²K/W
AF01	Außenfenster	1.100	0.909	0.130	0.040	0.739
AT01	Außentür	1.700	0.588	0.130	0.040	0.418
AW01	Außenwand	0.220	4.545	0.130	0.040	4.375

Raum	Φ_{ext}	A_{ext}	Φ_{ext}	Φ_{int}	Φ_{v}	$\Phi_{residual}$	$\Phi_{residual}$	$\Phi_{residual}$	$\Phi_{residual}$	$\Phi_{residual}$
Nr.	Bezeichnung	°C	m²	W	W	W	W	W	W	W
Haus, EG			180.88	5427		3396			9160	0
00.001.001	Ellern	20.0	29.10	833	833	501	46	15	1335	0
00.001.002	Kinder	20.0	20.49	752	752	343	54	19	1106	0
00.001.003	Vorraum	20.0	24.40	571	571	409	40	14	980	0
00.001.004	Bad	20.0	11.00	300	300	120	11	4	289	0

▲ Extract from a heating load calculation

5.2 Variotherm dimensioning software

Key values for individual heating circuits (the amount of water, pressure loss, number of circuits, allocation of the manifolds etc.) can be quickly and easily calculated by inputting the heating load into the Variotherm dimensioning software. It can be found in our Professional Area at www.variotherm.com/profi

Building project: Simon Sample ZIP: 2544 City: Leobersdorf Date: _____ Processed by: _____

No.	Room name	Floor space	Maximum length of DOH L [m]	Heating load Q [W]	Supplement heating load Up [W]	Heating load incl. Supplement Q _{tot} [W]	Room temp. t _r [°C]	Heat transfer system	Floor covering FH [t/m²]	Dimensioning temperature t _{dim} [°C]	Mathematical		Practical		Supply pipe	Supply line length [m]	Pressure loss per circuit [mWC]	Flow quantity per circuit [kg/h]	Distribution manifold number		
											Dim.	Unit	Type	No. Of circuits						Dim.	Unit
G																					
	living room	53.00		2860		2.860	22	Compact floor heating	0.075	40/30	51.10 m²	K RA10	8	6.6 m²	RA10	97	26		0.48	32	B1
	kitchen	17.20		1021		1.021	20	Compact floor heating	0.010	40/30	16.30 m²	K RA20	2	6.3 m²	RA10	25	27		0.80	46	B1
	porch	5.00		458		458	18	Compact floor heating	0.010	40/30	5.00 m²	K RA10	1	5 m²	RA10	7	27		0.55	41	B1
	bathroom	4.20		231		231	24	Compact floor heating	0.010	40/30	3.90 m²	K RA10	1	4.2 m²	RA10	21	27		0.16	22	B1
	WC	2.00		134		134	20	Compact floor heating	0.010	40/30	1.70 m²	K RA10	1	2 m²	RA10	32	27		0.05	15	(B1)
													1								
B																					
	room 1	15.00		954		954	20	Compact floor heating	0.075	40/30	14.50 m²	K RA10	3	5 m²	RA10	36	26		0.30	29	B2
	room 2	14.00		878		878	20	Compact floor heating	0.075	40/30	13.40 m²	K RA10	2	7 m²	RA10	46	26		0.74	40	B2
	room 3	17.00		969		969	20	Compact floor heating	0.075	40/30	14.70 m²	K RA10	3	5.6 m²	RA10	140	26		0.41	32	B2
	room 4	16.00		953		953	20	Compact floor heating	0.075	40/30	14.50 m²	K RA10	3	5.3 m²	RA10	96	26		0.36	31	B2
	aisle	19.50		1624		1.624	20	Compact floor heating	0.010	40/30	19.50 m²	K RA10	3	6.5 m²	RA10	-8	27		0.86	47	B2
	WC	3.50		273		273	20	Compact floor heating	0.010	40/30	3.30 m²	K RA10	1	3.5 m²	RA10	18	27		0.17	26	B2
													1								
													1								
													1								
													1								
													1								
													1								
													1								
													1								
													1								
													1								
													1								
													1								
													1								
													1								
													1								
													1								
													1								
													1								
													1								
													1								
													1								
													1								
													1								

Summary of the heating systems

Amount	Unit	Heating system	Type	Pipe / Heating element
	m²	System wall heating	SWHK2	
	m²	System wall heating	SWHK3	
	m²	Modular wall heating	MWHKF	
	m²	EasyFlex wall heating	EWH77F	
	m²	EasyFlex wall heating	EWH77	
	m²	EasyFlex wall heating	EWH77	
	m²	EasyFlex wall heating	EWH77	
	m²	Modular ceiling heating	MDKH-F	
	m²	Screed floor heating	RA10	
	m²	Screed floor heating	RA15	
	m²	Screed floor heating	RA20	
	m²	Screed floor heating	RA25	
	m²	Screed floor heating	RA30	
161.3	m²	Compact floor heating	RA10	1.613.0 Hm
	m²	Compact floor heating	RA20	
	m	Skirting heating	Htmini	
	m	Skirting heating	HtLa	
	m	Skirting heating	HtLa	
	m	Skirting heating	HtLa	
	m	Ducted channel heating	BKH1mini	
	m	Ducted channel heating	BKH1	
	m	Ducted channel heating	BKH2mini	
	m	Ducted channel heating	BKH2	
	m	Supply pipe	16x2	
	m	Supply pipe	11,6x2	
		Total filling water		93.6 litres

Summary of pipe length by line

Line	Room	m @ 16	m @ 11.6	Line	Room	m @ 16	m @ 11.6
1	living room	520.0	14	14			
2	kitchen	126.0	15	15			
3	porch	50.0	16	16			
4	bathroom	42.0	17	17			
5	WC	20.0	18	18			
6			19	19			
7			20	20			
8	room 1	150.0	21	21			
9	room 2	140.0	22	22			
10	room 3	168.0	23	23			
11	room 4	159.0	24	24			
12	aisle	195.0	25	25			
13	WC	35.0					
	TOTAL						1.613.0

Summary of the floor heating surface area

Screed floor heating	m²	
Compact floor heating	m²	161.3

Summary of loads

Summary of heating load	10.355 W
Summary of installed load	10.867 W

	t/lt	Number of heating circuits	Flow quantity manifold [kg/h]	Max. pressure loss + 0.1 mWC for manifold [mWC]	Manifold notation according to drawing
Distribution manifold B1	40/30	12	428	0.50	
Distribution manifold B2	40/30	15	523	0.36	
Distribution manifold B3					
Distribution manifold B4					
Distribution manifold B5					
When all distribution manifolds are fed via one pump, the following applies:					
Total flow quantity:			949	kg/h	
Maximum pressure loss from distribution manifold incl. 0.1mWC for max. opened valve			0.36	mWC	

▲ Variotherm dimensioning software example for heating

5.3 Heat output tables

Thermal resistance d/λ : 0.01 – 0.02 m²K/W

Caution! The flow temperature must never exceed 50 °C

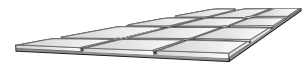

tiles, ceramic and natural stone coverings

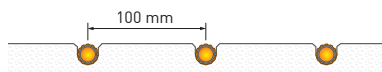

t_f/t_r [°C]	t_{mH} [°C]	Heat output [W/m ²] at room temperature...					T_0 [°C] <small>(at $T_r = 20$ °C)</small>
		...15 °C	...18 °C	...20 °C	...22 °C	...24 °C	
30/20	25.0	53	38	27	16	-	23
30/25	27.5	67	51	40	29	18	24
35/25	30.0	82	65	53	43	32	25
35/28	31.5	89	73	62	51	41	25
35/30	32.5	95	79	68	57	47	26
37.5/32.5	35.0	109	93	83	70	60	27
40/30	35.0	109	93	83	70	60	27
40/35	37.5	124	108	97	85	74	29
45/35	40.0	138	122	110	99	88	29
45/40	42.5	153	137	126	114	102	31
50/40	45.0	168	152	140	129	117	32
50/45	47.5	183	165	154	143	132	33

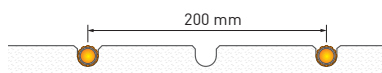

Not suitable for living rooms or bare-foot areas!

t_f/t_r [°C]	t_{mH} [°C]	Heat output [W/m ²] at room temperature...					T_0 [°C] <small>(at $T_r = 20$ °C)</small>
		...15 °C	...18 °C	...20 °C	...22 °C	...24 °C	
30/20	25.0	40	28	20	12	-	22
30/25	27.5	51	38	30	22	14	23
35/25	30.0	62	50	41	33	24	24
35/28	31.5	68	56	47	39	30	24
35/30	32.5	73	60	52	44	35	25
37.5/32.5	35.0	84	71	63	54	46	26
40/30	35.0	84	71	63	54	46	26
40/35	37.5	94	82	72	65	57	26
45/35	40.0	105	93	84	75	67	27
45/40	42.5	117	105	95	87	78	29
50/40	45.0	128	116	106	98	89	29
50/45	47.5	139	126	118	110	100	31

$$t_{mH} = \text{mean hot water temperature} = \frac{t_f + t_r}{2} \text{ [°C]}$$

T_r = room temperature [°C]

T_0 = mean surface temperature [°C]

t_f/t_r = flow temperature / return temperature [°C]

Thermal resistance d/λ : 0.075 m²K/W

Caution! The flow temperature must never exceed 50 °C

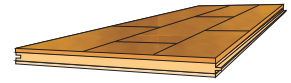

thin parquet floors,
laminates and carpets

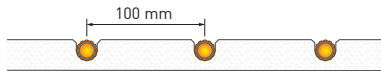

t_f/t_r [°C]	t_{mH} [°C]	Heat output [W/m ²] at room temperature...					T_0 [°C] (at $T_r = 20$ °C)
		...15 °C	...18 °C	...20 °C	...22 °C	...24 °C	
30/20	25.0	41	29	21	12	-	22
30/25	27.5	53	40	32	24	15	23
35/25	30.0	65	52	43	35	26	24
35/28	31.5	72	58	49	41	32	24
35/30	32.5	77	62	53	45	37	25
37.5/32.5	35.0	87	74	66	56	48	26
40/30	35.0	87	74	66	56	48	26
40/35	37.5	98	86	77	67	59	27
45/35	40.0	111	98	88	80	70	28
45/40	42.5	121	108	99	91	81	29
50/40	45.0	134	122	112	102	93	30
50/45	47.5	145	131	122	113	103	31

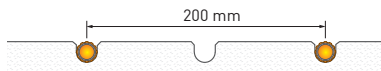

Not suitable for living rooms or bare-foot areas!

t_f/t_r [°C]	t_{mH} [°C]	Heat output [W/m ²] at room temperature...					T_0 [°C] (at $T_r = 20$ °C)
		...15 °C	...18 °C	...20 °C	...22 °C	...24 °C	
30/20	25.0	34	23	17	10	-	22
30/25	27.5	42	32	26	19	13	23
35/25	30.0	51	40	34	28	20	23
35/28	31.5	56	45	38	32	25	23
35/30	32.5	60	49	42	35	29	24
37.5/32.5	35.0	69	59	52	44	38	25
40/30	35.0	69	59	52	44	38	25
40/35	37.5	78	68	60	53	47	25
45/35	40.0	87	77	70	64	56	26
45/40	42.5	95	85	78	71	65	27
50/40	45.0	106	96	88	81	73	28
50/45	47.5	115	104	96	89	82	29

$$t_{mH} = \text{mean hot water temperature} = \frac{t_f + t_r}{2} \text{ [°C]}$$

T_r = room temperature [°C]

T_0 = mean surface temperature [°C]

t_f/t_r = flow temperature / return temperature [°C]

HEAT OUTPUT for a floor covering with a thermal resistance¹ of $d/\lambda = 0.01 / 0.05 / 0.075 / 0.10 \text{ m}^2\text{K/W}$

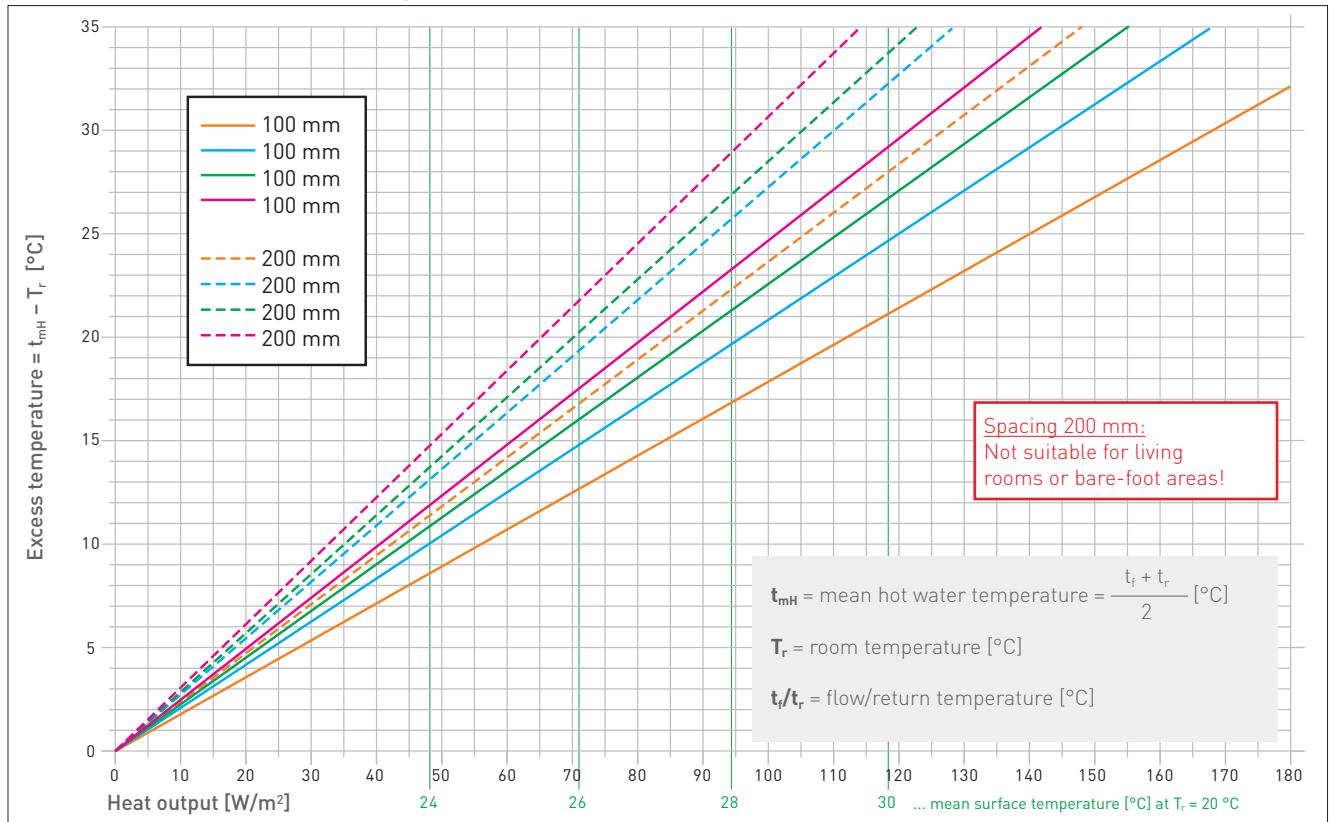

HEAT OUTPUT for a floor covering with a thermal resistance¹ of $d/\lambda = 0.12 / 0.14 / 0.16 / 0.18 \text{ m}^2\text{K/W}$

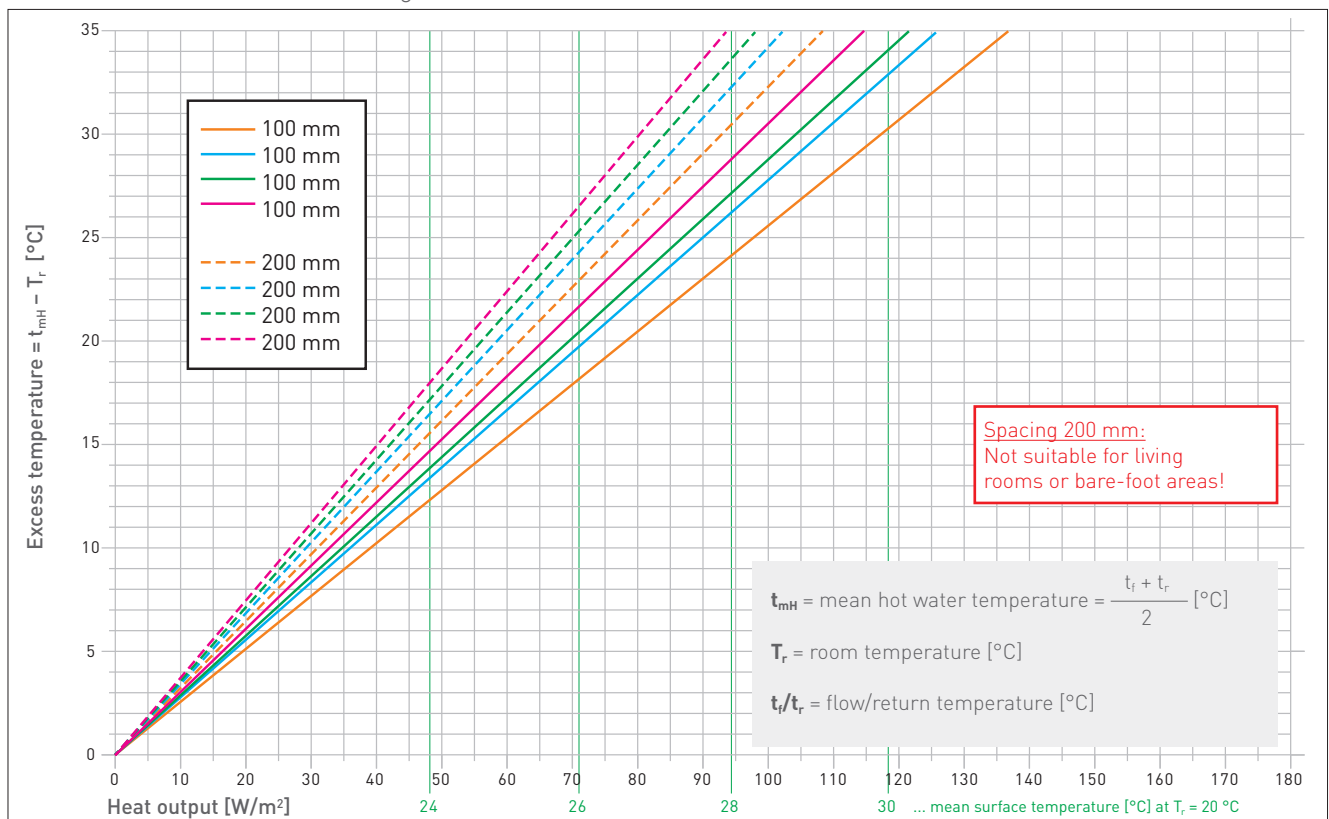

¹ Guidelines for the thermal resistance of various floor coverings see chapter 8.1

6 PIPING

The required thermal output of the individual room determines the spacing between the pipes:

- 100 mm: living rooms and barefoot areas to create a pleasant room atmosphere
- 200 mm: e.g. workshop, halls, laboratories, etc.

Maximum pipe length per heating circuit including supply pipe: 80 m

Pipe spacing	Pipe requirement
100 mm	10 m/m ²
200 mm	5 m/m ²

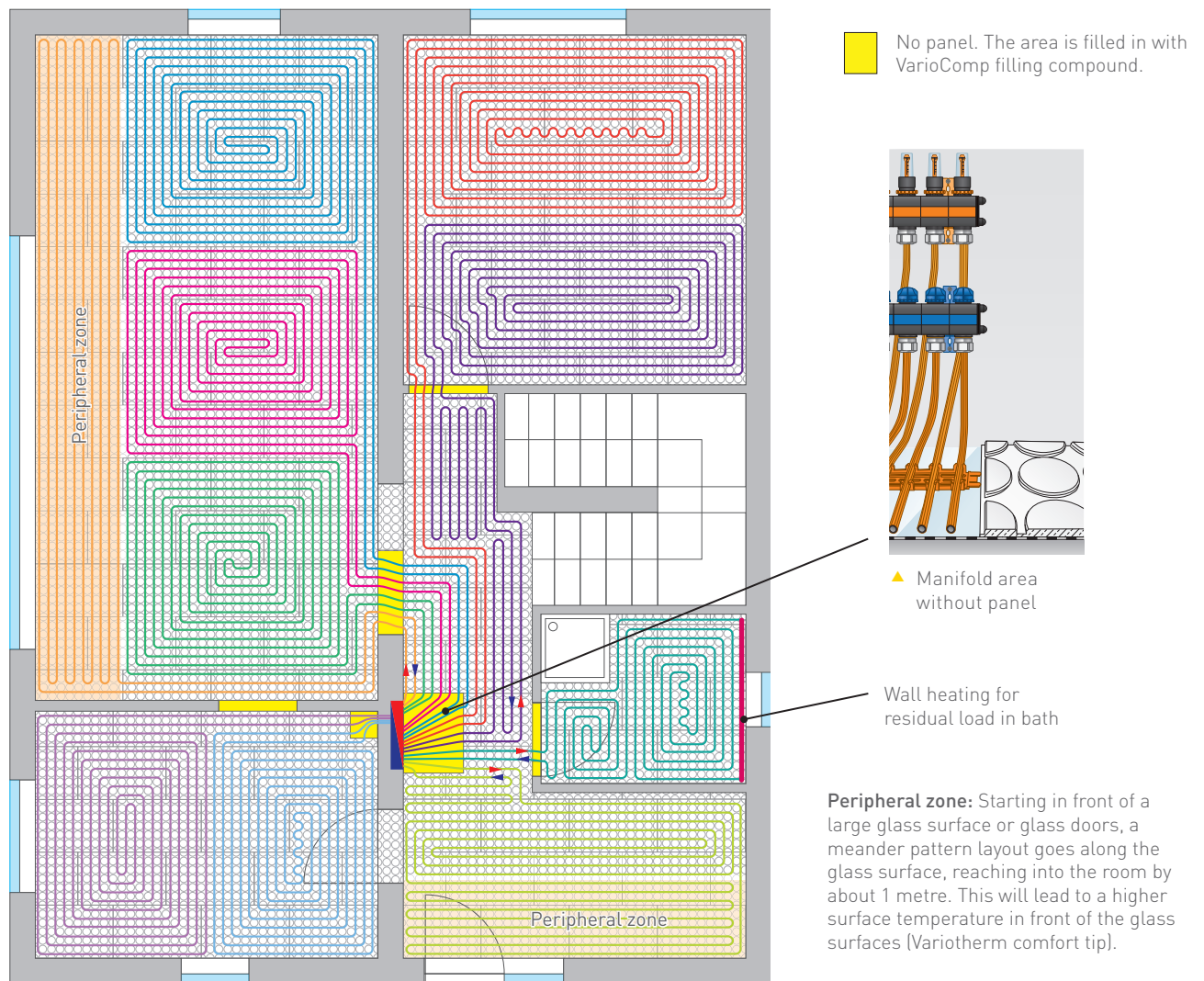
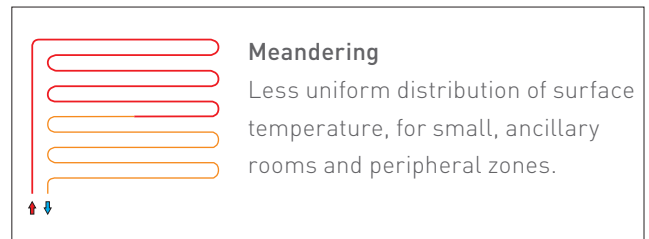
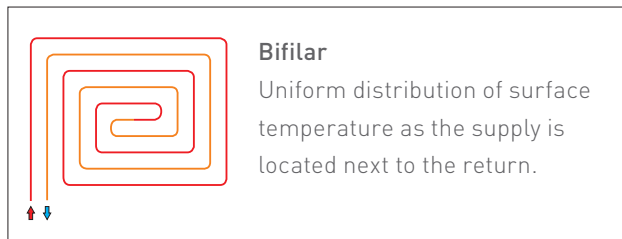

▲ Laying example of a single-family house with a constant pipe spacing of 100 mm

7 PRESSURE LOSS

Example: The total pressure loss Δp_{total} of a 7.2 m² VarioComp heating surface (1 heating circuit) is to be calculated. The desired flow/return temperature is 37.5/32.5 °C, resulting in a heat output of 66 W/m² at a room temperature of 20 °C (thin parquet, $d/\lambda = 0.075 \text{ m}^2\text{K/W}$).

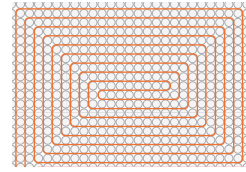

The total pressure loss Δp_{total} is calculated using the following components:

- Pipes and press-fit couplings
- Heating/cooling distribution manifold
- Boiler house (mixing valve, boiler ...)

1. Pipes and press-fit couplings

Calculation of the flow rate ω from the pressure loss diagram:
 $Q = 475.2 \text{ W}$ ($66 \text{ W/m}^2 \times 7.2 \text{ m}^2$)
 $\Delta T = 5 \text{ K}$ ($t_f/t_r = 37.5/32.5 \text{ °C}$)
 $\text{Flow volume } m = Q / c / \Delta T = 475.2 \text{ W} / 1.163 \text{ Wh/kgK} / 5 \text{ K} = 81.7 \text{ kg/h}$
 A flow volume $m = 81.7 \text{ kg/h}$ (= l/h) yields a flow rate $\omega = 0.4 \text{ m/s}$

Pipe length for 7.2 m ² heating surface:	
72 m (1 m ² = 10 m pipe at 100 mm pipe spacing)	
Press-fit coupling	Coefficient of resistance ζ (Zeta)
16 x 11.6	6.9
11.6 x 11.6	7.2
Density of water ρ (Rho)	1,000 kg/m ³
Specific heat capacity of water c	1.163 Wh/kgK

- Δp for 7.2 m² VarioComp: $335 \text{ Pa/m} \times 72 \text{ m} = 24,120 \text{ Pa}$ (pipe laid "endless")

In case of setting a press-fit coupling for connecting residual lengths of pipe:

- Δp for 1 pce. press-fit coupling 11.6 x 11.6: $\zeta \times \rho/2 \times \omega^2 = 7.2 \times 500 \text{ kg/m}^3 \times (0.4 \text{ m/s})^2 = 576 \text{ Pa}$

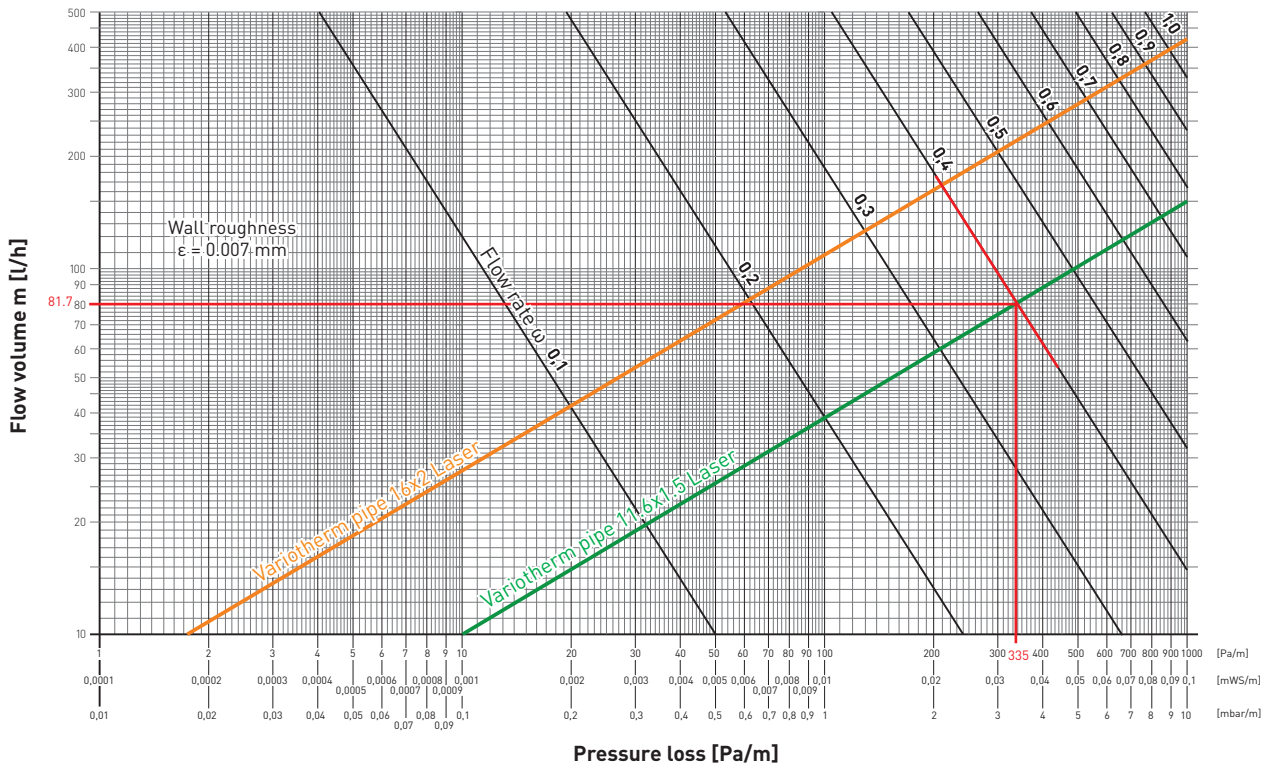

2. Heating/cooling distribution manifold

The flow rate characteristic curves for calculating the pressure loss of the heating/cooling distribution manifold for the heating circuits in question.

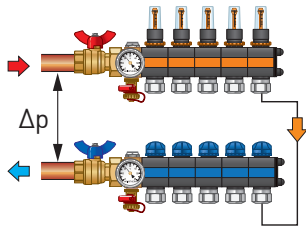

- Δp of the heating/cooling distribution manifold with an open valve up to $81.7 \text{ l/h} = 900 \text{ Pa}$

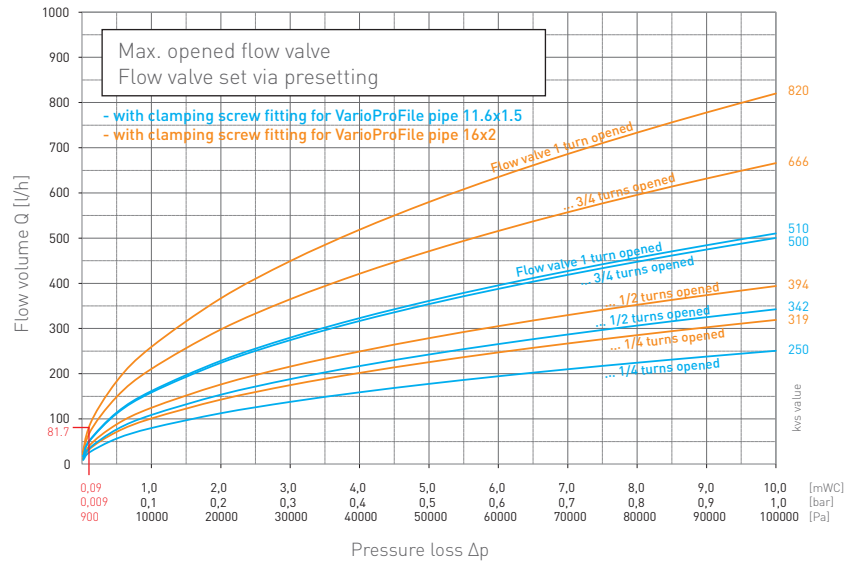

3. Boiler house (assumptions)

- Δp Mixing valve = 6,000 Pa
- Δp Connection piping = 3,500 Pa
- Δp Boiler = 3,000 Pa

4. Total pressure

- $\Delta p_{\text{total}} = 37,520 \text{ Pa} = 3.75 \text{ mWC}$

5.) Selection of the heating circulation pump (example: Wilo Yonos PICO Plus 25/1-6)

At the calculated pressure loss of 3.75 mWS the pump supplies a maximum volume flow of $1.65 \text{ m}^3/\text{h}$.

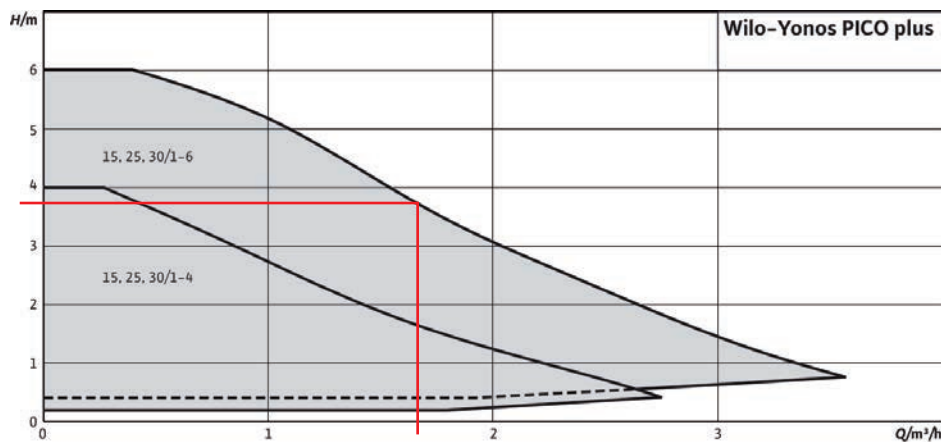

- ▲ Example: Wilo Yonos PICO Plus 25/1-6 heating circulation pump

8 FLOOR COVERING

8.1 General

- The floor covering used must be suitable for floor heating systems (observe the manufacturer's instructions).
- The surface of the VarioComp complies with ÖNORM DIN 18202 (Table 3 – limits for evenness deviations, Row 3):

Measuring point spacing	0.1 m	
Pitch max.	2 mm	

Recommendation: Use floors having a maximum thermal resistance of 0.15 m²K/W.

Guidelines for the thermal resistance R [m²K/W] of various floor coverings:

Floor covering	Thickness	Thermal resistance R = d/λ [m ² K/W]
Tiles	8 mm	0.01
Clinker slabs	11 mm	0.01 – 0.02
Marble	10 mm	0.01
Natural stone slab	12 mm	0.01
Linoleum	2.5 mm	0.015
PVC coverings	2.5 mm	0.01 – 0.02
Adhesive cork	5 mm	0.01
Prefinished parquet floor (2-layer)	10 mm	0.05 – 0.07
Prefinished parquet floor (3-layer)	14 mm	0.07 – 0.10
Laminate	9 mm	0.05
Thin carpet	6 mm	0.07 – 0.11
Medium-thick carpet	9 mm	0.11 – 0.15
Thick carpet	13 mm	0.15 – 0.24

Caution: The floor covering should be laid as quickly as possible to avoid any soiling of the surfaces or damage to the pipes.

8.2 Residual humidity of the VarioComp filling compound

Before laying the floor covering, the VarioComp filling compound must be dried in accordance with the following table:

Floor covering (Take note of the manufacturer's instructions!)	CM value (remove 100 g of filling compound for measuring)	Drying time (estimated at t _i = 20 °C, max. 50 % relative humidity)	
		without baking out	with baking out ¹ at t _i = 40 °C
Stone & ceramic coverings in a thin bed	1.3 %	6 days	24 h
Wood covering, parquet	0.3 %	8 days	36 h
Linoleum, PVC, vapour tight floor covering (the levelling mass has already been applied in accordance with Chapter 8.4)	0.3 %	not possible	≥ 48 h

¹ At t_i = 20 °C, you must wait at least 2 hours after finishing applying the filling compound before beginning the baking out process.

8.3 Borders between VarioComp panels and blank panels (at bonding of floor coverings)

Cover the borders using glass fibre cloth (4 x 4 mm) at an overlap of 200 mm (e.g. bond using tile adhesive).

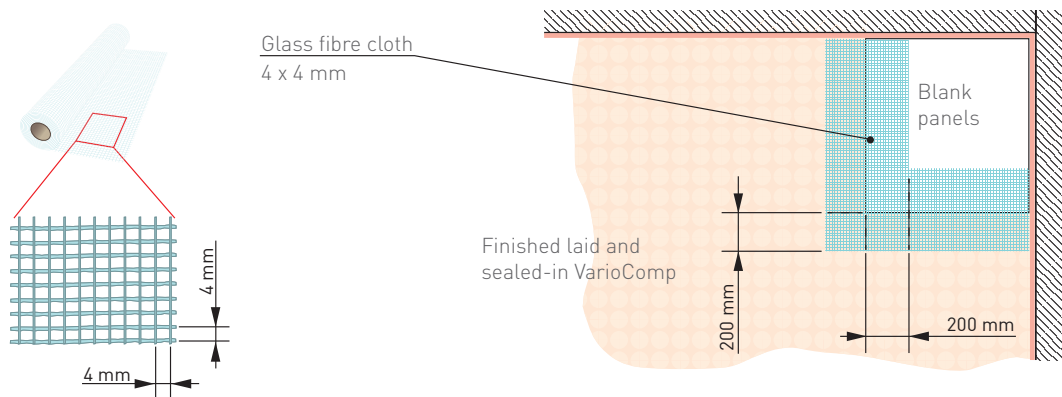

8.4 Levelling out with a calcium sulphate floor levelling compound

In the following cases, the finished VarioComp surface is additionally levelled with a calcium sulphate floor levelling compound:

- For soft floor coverings and synthetic resin floors (see chapter 8.7)
- Depressions which exceed the standard tolerances (see chapter 8.1) or which are too high for the floor covering according to the floor installer

Brand	Primer	Calcium sulfate floor-levelling compound
Mapei	Primer G	Planitex D10
Schönox	Schönox VD, PG	Schönox AP
Maxit	maxit floor 4716	maxit floor 4095
Fermacell	Tiefengrund	Boden-Nivelliermasse
Thomsit	R766, R777	AS1, AS2
Stauf	D54	GS
Murexin	D7	CA 40
Baumit	Grund	Nivello Quattro
Smet	Universal Floor Primer	SHG Casufloor FS
Ardex	Ardex P51	Ardex K22
Wakol	D 3040	A 620

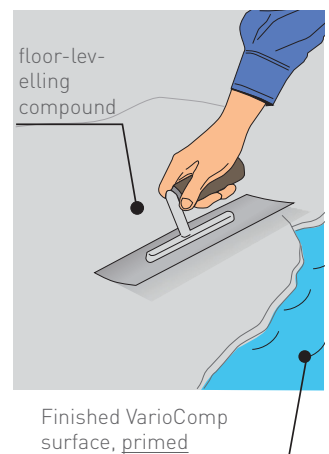

8.5 Compound sealing in rooms exposed to high humidity

For surfaces which are exposed to high levels of humidity, sealing systems must be applied (e.g. bathrooms with shower trays - W3).

The wall construction must be sealed using sealing system and additional sealing tape.

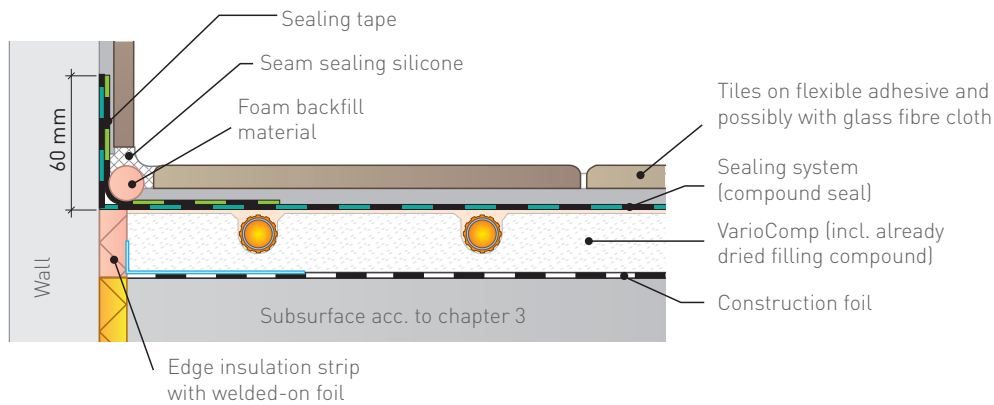

<< Example:
Tiled floor covering subject to the effects of moisture (W2/W3) [More details for tiled covering on VarioComp see chapter 8.6]

Use of primer and sealing system (compound sealing):

Operational demands group		Which room?	Adhesive mortar with tile coverings	Primer	Sealing system
ÖN B 3407	ZDB composite waterproofing (Germany)				
W1	-	Residential sector: living rooms, corridors, toilets, offices and the like	Calcium sulfate flexible adhesive mortar	Not required	Not required
			Cement flexible adhesive mortar	Required	Not required
W2	-	Residential sector: kitchen and rooms with similar usage Commercial sector: toilet systems	Only cement flexible adhesive mortar	In addition to the sealing system, when recommended by the manufacturer	Recommended
W3	A0	Wall and floor surfaces without drainage (e.g. bathroom with shower tub), toilet systems without floor drainage, porch	Only cement flexible adhesive mortar	In addition to the sealing system, when recommended by the manufacturer	Required
W4 - W6	B0, A, B, C	Wall and floor surfaces with drainage (e.g. shower with flush drain at the same level as the floor), swimming bath area, shower systems, industrial kitchen, balconies, terraces ...	No VarioComp floor heating possible.		

Product examples for primer or sealing system (compound sealing):

Manufacturer / Brand	Primer	Sealing system
Ardex	Ardex P51	Ardex 8 + 9
Murexin	Tiefengrund LF1	Flüssigfolie 1KS
Cimsec	Gipsgrundierung / Haftbrücke	Dichtflex CL51 / 2K Abdichtung CL49
PCI (BASF)	Gisogrund	Lastogum
Schönox	Schönox KH	Schönox HA / 1K DS Premium
Mapei	Primer G	Mapegum WPS
Weber	weber.prim 801	weber.tec 822
Ceresit	Lösungsmittelfreier Tiefengrund CT17	Ceresit Dusch- & Badabdichtung
Sopro ¹	GD 749	Flächendicht flexibel FDF 525/527

¹ For more details, see the Sopro installation recommendations (available on request).

8.6 Stone and ceramic coverings

See also the appropriate standards for laying tiles, panels and mosaics.

- The surface must be dust-free.
- Sealing systems must be used on surfaces subject to the effects of moisture (see chapter 8.5).
The wall boundaries must be sealed using appropriate sealing tape.
- A flexible adhesive (S1 classified according to EN 12004) is used to bond the tiles. A primer must be applied if required by the adhesive manufacturer. This is particularly the case for flexible cement adhesives.
- Flexible grouting mortar must be used for grouting.
- After laying the tiles, boundaries with the walls are additionally sealed with silicone.

For critical floor structures, we recommend integrating a 4 x 4 mm fibre glass cloth into the flexible adhesive.

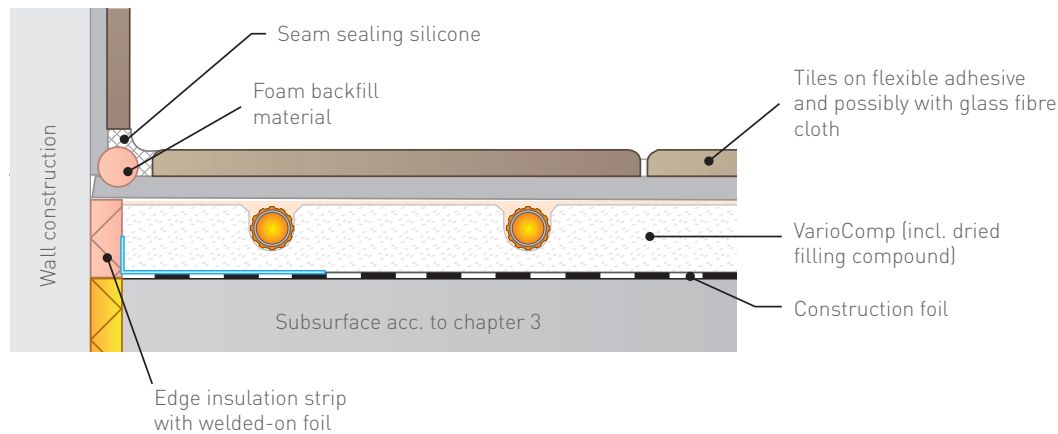

8.7 Linoleum, carpet, PVC floor covering and synthetic resin floors

For soft floor coverings and synthetic resin floors, a calcium sulphate-based floor-levelling compound (provided by customer) at least 4 mm thick is laid over the completed VarioComp (see chapter 8.4).

Caution: Only use synthetic resin floors with low thickening tension (polyurethane-based)!

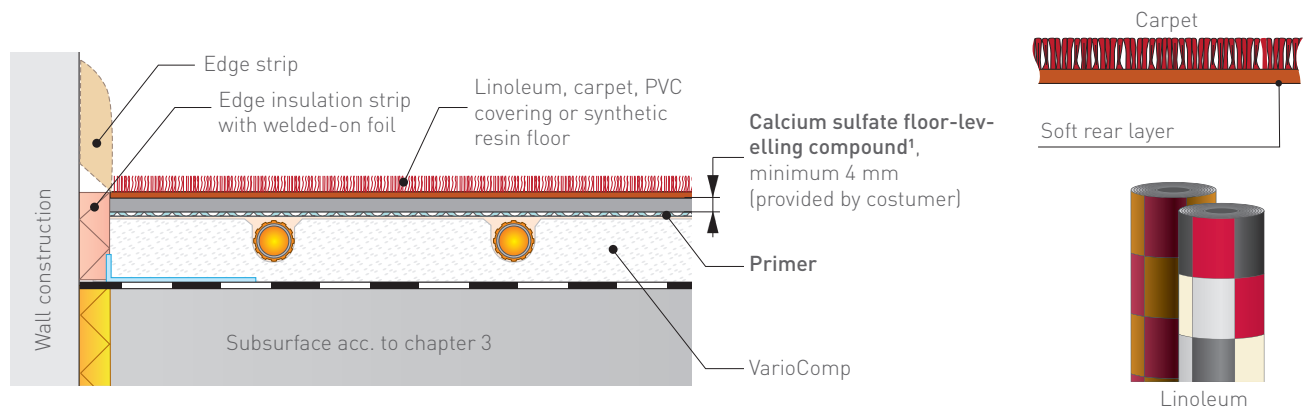

¹ Please observe the relevant manufacturer's instructions for the required primer or sealant of the VarioComp surface and of the planned floor-levelling compound. Product examples see chapter 8.4.

Work cannot be started earlier than 48 hours after applying the VarioComp filling compound.

8.8 Wood covering, parquet and laminate

- **It is not necessary and prohibited to abrade the surface of the finished VarioComp!**
- Lay only floor coverings that are approved by the manufacturer for use with floor heating systems.
- We recommend a covering with a maximum thermal resistance of 0.15 m²K/W.

FLOATING APPLICATION:

- The laminate/parquet covering is laid floating on an underlay suitable for floor heating (max. 2 mm).
- The edge seam to adjacent components should be at least 10 mm

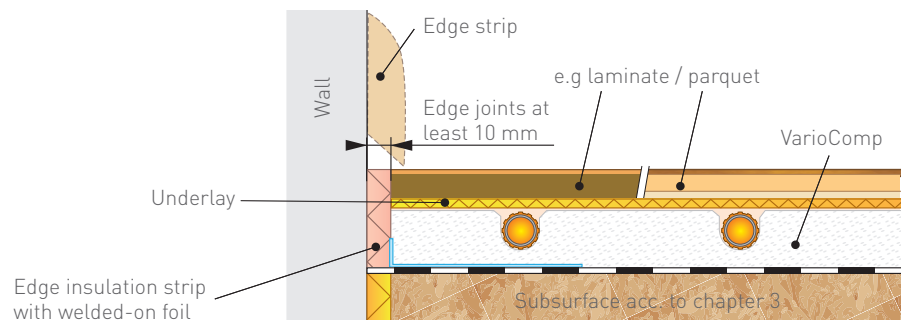

ADHESIVE PARQUET:

Parquet can be glued onto the VarioComp under the following conditions:

- 2 or 3 layer parquet suitable for floor heating, without gluing the tongue and grooves.

It is prohibited to glue solid wood flooring!

- Maximum flow temperature 40 °C (Maximum temperature limiter required!)
- Gluing without primer using e.g.:
 - Mapei Ultrabond P990 1K / Eco P991 1K
 - Thomsit P695
 - Ardex Premium AF2420
 - Weitzer Parkett Profi-SMP adhesive Nr. 400-EC1
 - Sika SikaBond-52 Parquet and SikaBond-54 Parquett

or equivalent adhesive (primer as per manufacturer's specifications).

- The parquet is glued either directly to the VarioComp system, or with decoupling fleece (observe the manufacturer's specifications!).

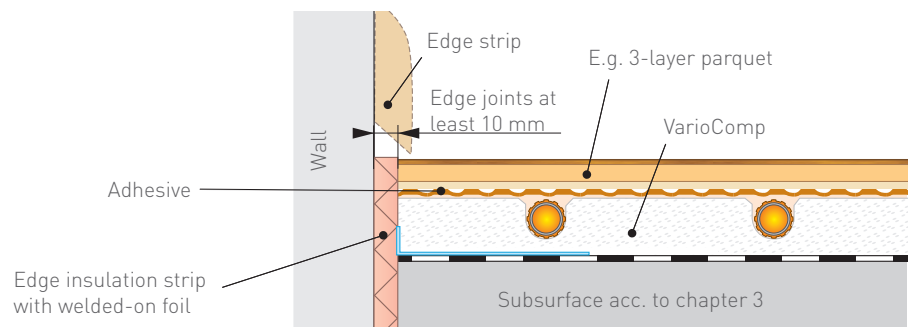

ENJOY THE COMFORT & SAVE ENERGY

That's why our customers love us:

Heating and cooling optimised for COMFORT in all rooms!

Fast and friendly service, ANSWERS backed up with expertise!

Always in tune with the latest technology, INNOVATION guaranteed!

Everything CLEAR and SIMPLE, in writing of course!

PROFESSIONALISM at all times, from the first contact to the reference list!

VARIO THERM SINCE 1979

Variotherm is an Austrian model plant with hundreds of partners in Austria, Europe and around the world.

All rights pertaining to distribution and translation, in whole or in part, including film, radio, television, video recording, Internet, photocopying and reprinting, are reserved. Subject to mistakes and printing errors. Misprints and errors excepted.



Austrian
Leading
Companies
2014



MFH



VARIO THERM HEIZSYSTEME GMBH

GÜNSELSDORFER STRASSE 3A

2544 LEOBERSDORF

AUSTRIA

Phone: 0043 22 56 - 648 70-0

Fax: 0043 22 56 - 648 70-9

office@variotherm.com www.variotherm.com