

# MCCH PLANNING

MODULAR CEILING COOLING. MODULAR CEILING HEATING.

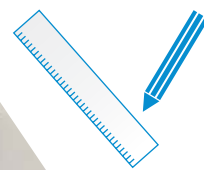

35/30 °C  
68 W/m<sup>2</sup>

16/20 °C  
60 W/m<sup>2</sup>



ModuleStandardCeiling.  
Classic and Acoustic



# TABLE OF CONTENTS

1	PRINCIPLES .....	4
1.1	Cooling .....	4
1.2	Heating.....	5
1.3	Energy savings.....	6
1.4	Adapts to suit your home.....	6
1.5	Description and advantages of the ModuleCeiling.....	7
2	COMPONENTS .....	8
2.1	Overview.....	8
2.2	ModuleStandardPanels .....	10
2.3	Variomodular pipe 11.6x1.5 Laser.....	12
3	FIRE PROTECTION .....	13
4	SUBSTRUCTURE.....	14
4.1	Dimensions in border area .....	14
4.2	Wooden substructure -directly fastened base runners .....	14
4.3	Wooden substructure - suspended base runners.....	15
4.4	Metal substructure - suspended base profile.....	15
4.5	Directly fastened cross joists (variant without main joists) .....	16
4.6	Movement joints.....	16
4.7	Residual areas and panel transitions.....	17
5	COOLING/THERMAL PERFORMANCE.....	18
5.1	Calculation of the cooling and heating load .....	18
5.2	Variotherm dimensioning softwares .....	18
5.3	Cooling performance .....	19
5.4	Heat output tables .....	19
6	PIPING.....	20
7	ARRANGEMENT OF THE SURFACES .....	21
8	PRESSURE LOSS .....	22
9	FINISHED SURFACE .....	24
9.1	Stopping .....	24
9.2	Painting .....	24
9.3	Fastening loads to the ModuleCeiling .....	24
10	ACOUSTIC .....	25
10.1	General.....	25
10.2	Panel variants .....	25
10.3	Acoustic values .....	26

# 1 PRINCIPLES

Comfortably heated rooms provide a pleasant and healthy room climate in recreation rooms. Thermal insulation and shadowing are usually insufficient for achieving this level of well-being in rooms in summer. The Variotherm ModuleCeiling is an ideal enhancement to the room cooling: The rooms are pleasantly cooled in summer and heated in winter to an even temperature.

## 1.1 Cooling

Comfort is not only created through a particular air temperature in the room. The temperature of the surfaces enclosing the room is of equal importance. The perceived temperature is roughly consistent with the arithmetic mean of both temperatures.

### What makes people feel comfortable?

People feel comfortable when the following basic "thermal comfort" equation holds:

$$\text{Heat production} = \text{heat loss}$$

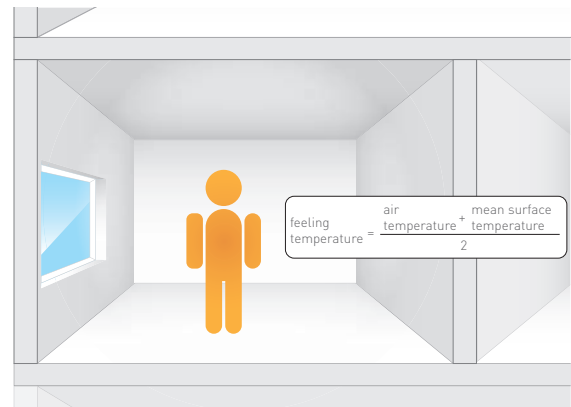

▲ Impact of the room on felt temperature

Cooling via ceiling surfaces offers the advantage of gentle radiation exchange between the cooled ceiling surface and the human body. Other warmer objects in this room (floor, interior walls, furnishings etc.) also radiate heat to this cooled surface, since thermal radiation always flows from the warmer to the colder object. This loss of heat reduces the surface temperature of these objects, thus providing a cooling effect. The ambient air in the room is also cooled to a comfortable level.

The ModuleCeiling does not generate uncomfortable forced air or noise, which are often regarded as annoying properties of conventional air-conditioning systems.

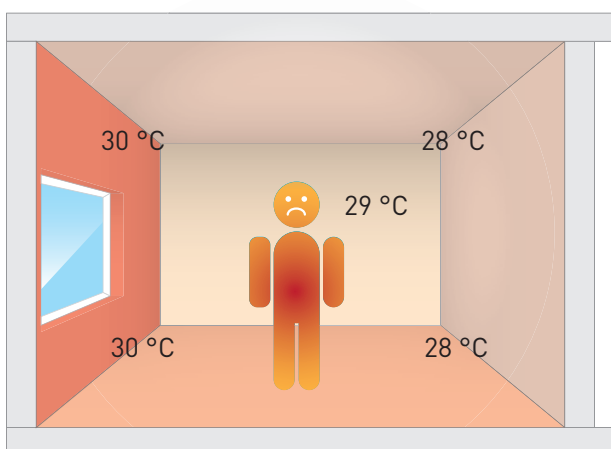

▲ Discomfort without cooling

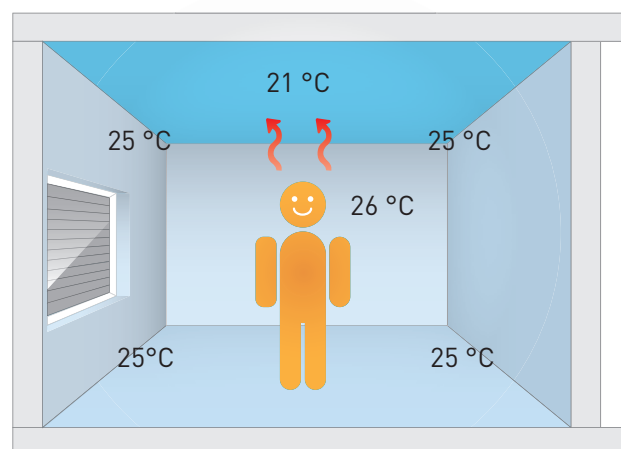

▲ Comfort with cooling

Based on experience, cooling makes sense at a room temperature  $\geq 26$  °C. To achieve a noticeable effect and suitably cool the body, a reduction of the ceiling surface temperature to approx. 19 - 22 °C is possible.

### Economy

The necessary cooling performance can be better distributed with water than with air. The pumping costs for surface cooling systems are usually significantly lower than the costs incurred by using fans. A 100 percent coverage of the cooling load, as per VDI 2078 (calculation of the cooling load for air-conditioned rooms), is possible in buildings designed for low energy consumption with shadowing equipment and low internal loads.

One of the major advantages of ceiling cooling/heating systems is the low additional investment costs. A single system is used for the cooling and heating modes: the same ceiling surface, same piping system and the same heating/cooling distribution manifold with supply lines and circulation pump. The generation of cooling (chiller/heat pump/cooling from the floor and ground water) is planned in parallel to the heating unit. Many modern heat pumps already allow switching from heating to cooling mode – without major extra costs. Ambient sources of cooling (deep boreholes, ground collectors, wells...) can also be used – at zero cost.

### Combination of displacement ventilation and surface cooling

Surface cooling does not replace an air-conditioning system with regard to dehumidification and ventilation. Displacement ventilation is an air-conditioning system with low air exhaust speeds and laminar flow of the escaping air at the exhaust vents. Low turbulence in the air flow through the room is achieved through the type of ducting in the room, blowing of air at floor level at a slightly subnormal temperature and extraction of the exhaust air at the ceiling level. This type of displacement flow, known as “displacement ventilation” can achieve almost complete freedom from draughts. The combination of ceiling cooling and displacement ventilation allows significantly higher cooling performance to be achieved compared to using only a displacement ventilation system, without exceeding thermally comfortable air speeds. If the supplied air is dehumidified then low ceiling surface temperatures, and thus high radiant cooling performance, can be achieved without the formation of condensation, even on hot and humid days.

## 1.2 Heating

The ModuleCeiling is not only suitable for cooling but is also perfectly suitable for heating when used in the correct manner.

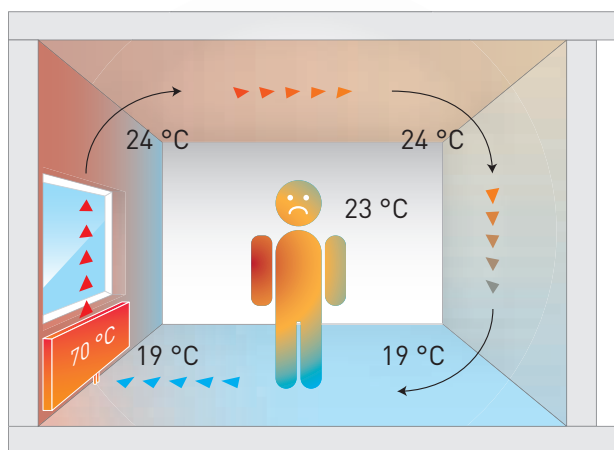

▲ Discomfort with radiators

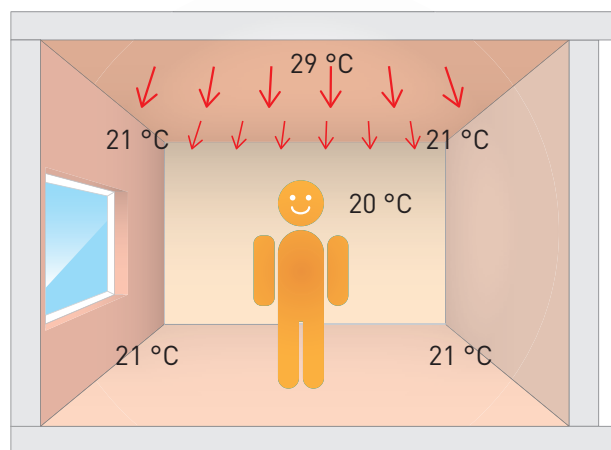

▲ Comfort with ceiling heating

The ModuleCeiling significantly increases the level of comfort compared to other heating systems. A lower room temperature can be chosen in comparison to convection heating because the radiant heat is perceived as warmer by people in the room.

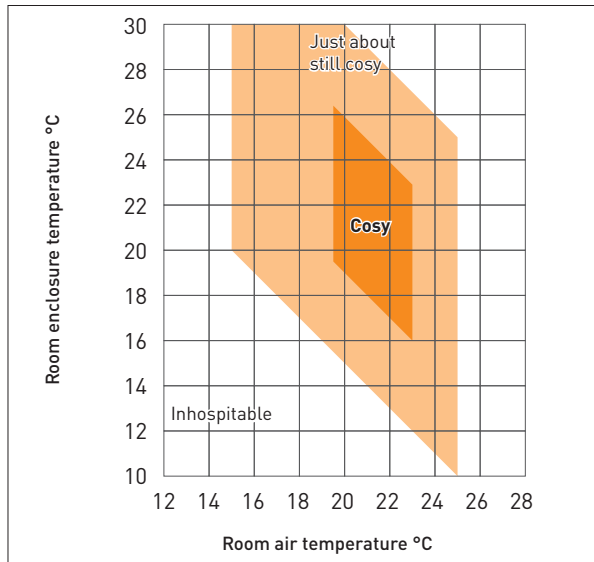

▲ Zone of cosiness

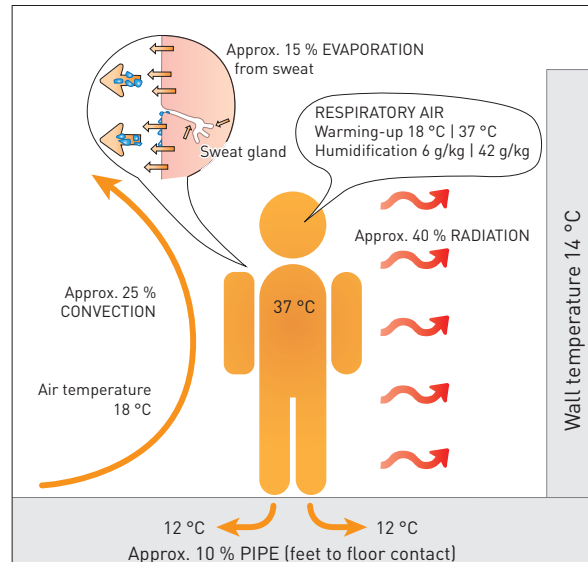

▲ Human heat balance

An important aspect of heat output from the human body is that this should occur as evenly as possible from all sides. We feel uncomfortable if too much heat is lost in one particular direction (e.g. cold surfaces, forced air) or the heat output is prevented in one direction (hot surfaces or vapour-tight, thick clothing). The lower the inside air temperature is, the warmer the surrounding surfaces (wall surfaces, floor and ceiling, as well as doors and windows) must be to ensure cosiness.

### 1.3 Energy savings

Energy losses are significantly reduced through an optimised ambient air temperature in conjunction with increased comfort. Heating cost savings of approx. 6 % per 1 °C reduced room temperature when heating or per 1 °C increased room temperature when cooling can be expected. This has the additional great physiological advantage of increasing the absorption of oxygen in the body of most people.

The ModuleCeiling system is ideal for use with low-temperature energy sources such as condensing boilers, heat pumps and solar collectors because it operates with low surface and heating medium temperatures. With the Variotherm ModuleCeiling you can achieve energy savings of up to 30 % compared to conventional heating systems.

### 1.4 Adapts to suit your home

The invisible cooling/heating ceiling eliminates the need for planning the installation of radiators and splitting devices. This saves a great deal of space and allows more freedom in designing the room layout: no restrictions in the wall and window designs or the interior architecture. Only the positions of the ceiling lights and spots need to be taken into consideration.

## 1.5 Description and advantages of the ModuleCeiling

The Variotherm ModuleStandardCeiling is an extremely energy efficient cooling and heating system. As a flexible panel system, it is pre-assembled for installation in ceilings and pitched ceilings. Here, heating, cooling and complete ceiling are perfectly combined in a single product. The desired room temperature is achieved by using hot and cold water circulation to make sure you feel completely comfortable all year round.

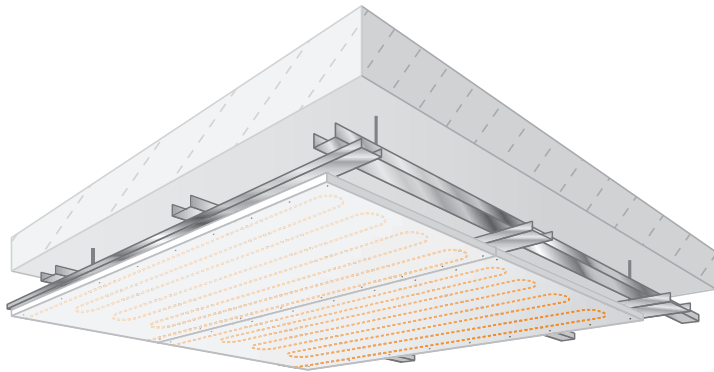

ModuleStandardCeiling-Classic  
for screwed ceilings  
10 different panel types,  
fire protection assessment

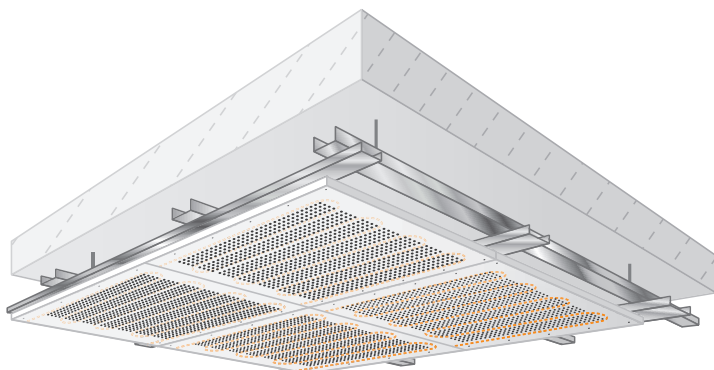

ModuleStandardCeiling-Acoustic  
for screwed ceilings  
ModuleStandardPanels with a  
sound-absorbent surface

### The advantages:

- Cooling, heating and finished ceiling in one
- With acoustic functionality if desired: With Variotherm, the holes of the acoustic panels are not covered by cooling/heating elements! This is the only way to ensure certified, guaranteed noise reduction.
- Ideal for timber-framed buildings, pre-fabricated houses, attics and renovation
- Cooling system: silent, no forced air, energy-efficient
- Heating system: large-surface, extremely energy-saving low temperature system
- Totally flexible panel system for all construction requirements
- Gypsum fibre boards and components tested for their healthy building properties
- Fire protection assessment for ModuleStandardCeiling-Classic (IBS Linz)



# 2 COMPONENTS

## 2.1 Overview

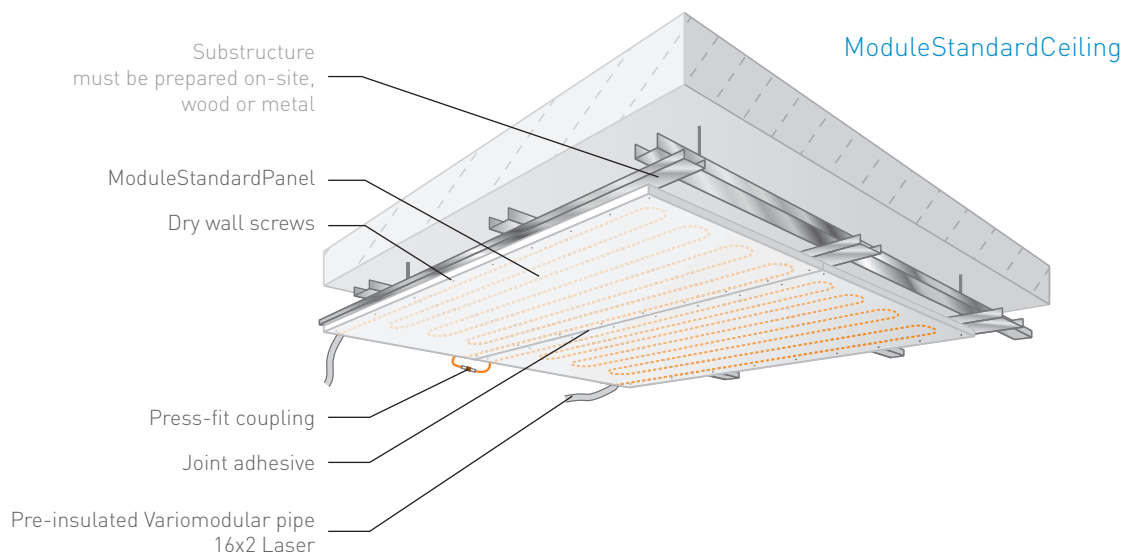

### Greenline joint adhesive

PG 021

for connecting the blunt adjoining modular panels.  
1 cartridge (310 ml) sufficient for 7 m<sup>2</sup>.

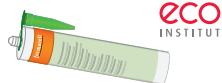

Part No.	PKU	Weight/PKU	Carton
F111	1 cartridge	550 g	25 cartridges

### Dry wall screws FCT40

PG 021

for joining modular panels to wooden/metal structures, incl. associated bit.  
Consumption: 16 pcs./m<sup>2</sup>

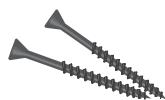

Part No.	PKU	Weight/PKU
F120-0250	Carton at 250 pcs.	0.6 kg
F120-1000	Carton at 1,000 pcs.	2.4 kg

### Duo adhesive

PG 021

for subsequent adhesion of ModulePanels. Breadth of assembly joints from 3 to 8 mm. 1 cartridge is sufficient for an approx. 7 m joint (with a breadth of 4 mm and a height of 18 mm). For each cartridge, we recommend 3 pieces of static mixing tube (F116). Caution: Special W048 manual applicator required!



Part No.	PKU	Weight/PKU	Carton
F115	1 cartridge	1 kg	10 pcs.
F116	1 static mixing tube	15 g	75 pcs.

### Pre-insulated 16x2 Variomodular pipe Laser

PG 130

- Aluminium multi-layer composite pipe 16x2 Laser (PE-RT/AL/PE-RT)
- No oxygen diffusion whatsoever
- 95 °C, 10 bar
- Insulation: Polyethylene soft foam  
Fire resistance as per EN 14313: CL-s1,d0



Part No.	Insulation thickness	PKU	Weight/PKU
V1226	6 mm	100 m roll	14.0 kg
V1227	9 mm	100 m roll	14.9 kg

### Adhesive tape

PG 031

As a separating layer to joint surfaces or between the panel contact points and the substructure, if required. Roll: 50 mm x 66 m



Part No.	PKU	Weight/PKU	Carton
V288	1 pce.	210 g	36 pcs.

### Duo manual applicator

PG 140

The matching manual applicator for applying the Duo adhesive.



Part No.	PKU	Weight/PKU
W048	1 pce.	1.4 kg
W050 (loan)	1 pce.	1.4 kg



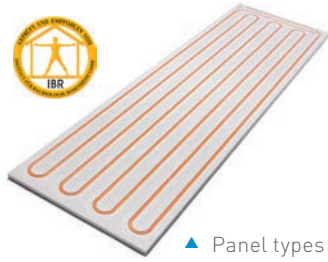

▲ Panel types see chapter 2.2

**Panel characteristics:**

**Panel:** gypsum fibreboard which has been tested for their healthy building properties

**Fire resistance as per DIN EN 13501-1:**

non-flammable, A2

**Identification as per DIN EN 15283-2:** GF-I-W2-C1

**Thermal conductivity  $\lambda$ :** 0.32 W/mK

**Apparent density  $\rho_K$ :** 1150 ± 50 kg/m<sup>3</sup>

**Water vapour diffusion resistance factor  $\mu$ :** 13

**ModuleStandardPanel-Classic**

- 18 mm thick gypsum fibreboard which has been tested for their healthy building properties
- With pre-installed Variomodular pipe 11.6x1.5 Laser at a grid size of 75 mm
- Marking of the screwing points (fastening area) on the front side

**ModuleStandardPanel-Acoustic**

The same properties as the "Classic" panel, but additionally with:

- Different sized holes to improve the acoustic characteristics
- Acoustic fleece on the rear side

Note:

The relative humidity must not exceed 70 % during storage, installation and additional processing of the ModulePanels and during the construction phase and normal use of the building. Wet plaster and wet screed must be applied and have dried before installation of the ModulePanels. The ModulePanels can be used in rooms up to moisture class W3 (ÖNORM B 3407). They are not approved for installation from moisture class W4 (e.g. canteens and shower blocks) upwards.

**Press-fit couplings**

PG 100

TH press-fit contour, incl. galvanic isolation, visual monitoring of insertion depth, tested as per EN 21003

Part No.	Type	Press-fitting jaws	PKU	Weight/PKU
Z1320	16 x 16	TH16	1 pce.	50 g
Z1610	16 x 11,6	TH16 & TH11.6	1 pce.	45 g
Z1600	11.6 x 11.6	TH11.6	1 pce.	30 g

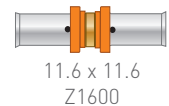
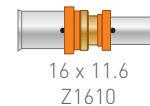
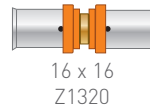

**Press-fit brackets 90°**

PG 100

TH press-fit contour, incl. galvanic isolation, visual monitoring of insertion depth, tested as per EN 21003

Part No.	Type	Press-fitting jaws	PKU	Weight/PKU
Z1370	16 x 16	TH16	1 pce.	50 g
Z1620	16 x 11,6	TH16 & TH11.6	1 pce.	45 g
Z1630	11.6 x 11.6	TH11.6	1 pce.	45 g

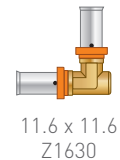
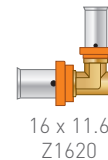
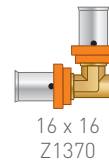

## 2.2 ModuleStandardPanels

### CLASSIC

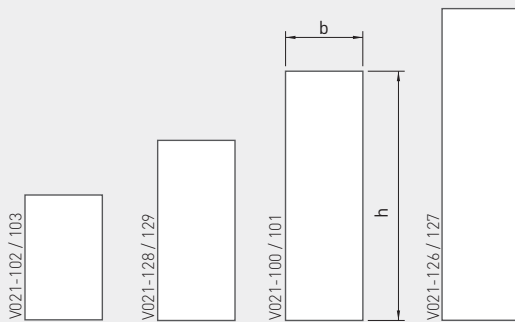
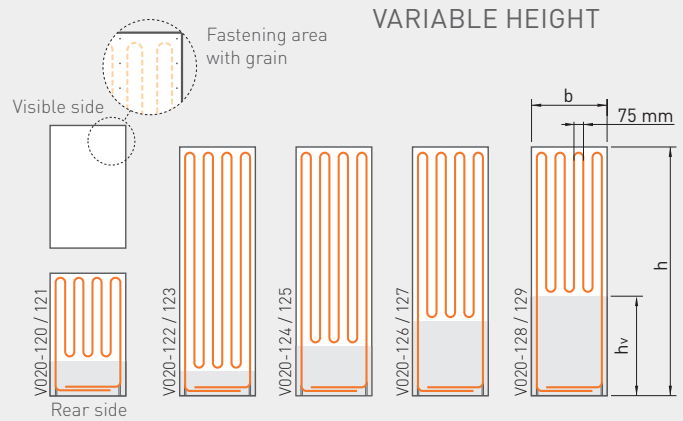
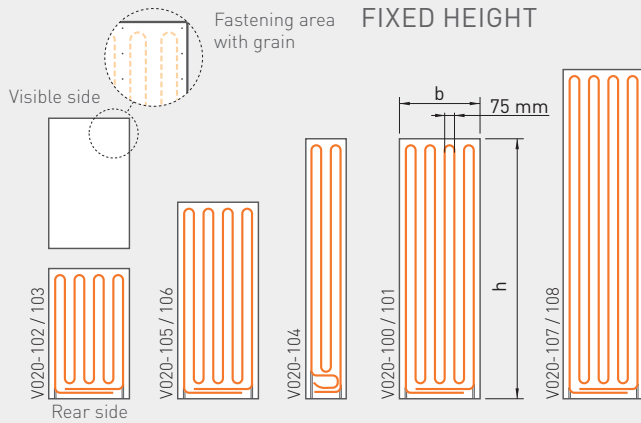

#### Fixed height panels:

The entire surface of the ModulePanel serves as a heating/cooling area.

#### Variable height panels:

Only part of the panel surface is used as a heating/cooling area, the unused area (grey) can be individually cut to size or used as a cutout region for recessed lighting.

ModuleExpansionPanels

### ACOUSTIC

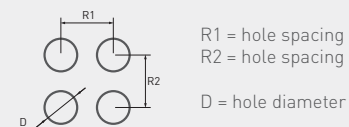
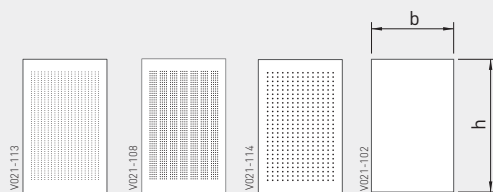
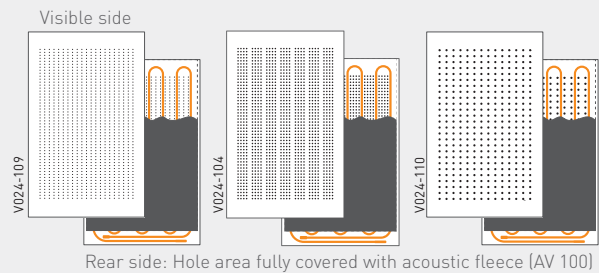
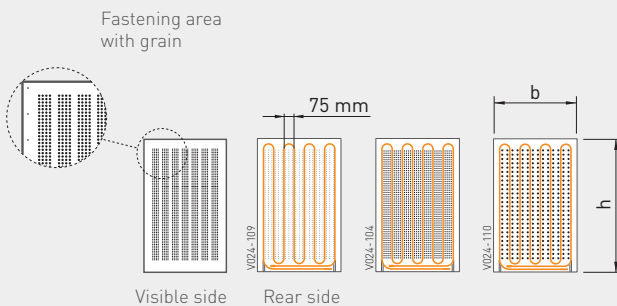

ModuleExpansionPanels

Part No.	Product code	Dimensions (h × b), [mm]	Height h, [mm]	Panel surface [m <sup>2</sup> ]	Effective surface [m <sup>2</sup> ]	Laid pipe in panel	Weight/ panel	Required quantity dry wall screws/panel			
								Longitudinal joists		Transverse joists	
<b>ModuleStandardPanels-Classic</b>											
V020-100	MSDC-2000-625	2,000 × 625	-	1.25	1.25	16.2 m	25.5 kg	18 pcs.	33 pcs.	25 pcs.	30 pcs.
V020-101	MSDC-2000-600	2,000 × 600	-	1.20	1.20	16.2 m	24.5 kg	18 pcs.	33 pcs.	25 pcs.	30 pcs.
V020-102	MSDC-1000-625	1,000 × 625	-	0.63	0.63	8.2 m	12.8 kg	10 pcs.	18 pcs.	9 pcs.	20 pcs.
V020-103	MSDC-1000-600	1,000 × 600	-	0.60	0.60	8.2 m	12.2 kg	10 pcs.	18 pcs.	9 pcs.	20 pcs.
V020-104	MSDC-2000-312	2,000 × 312	-	0.62	0.62	8.2 m	12.6 kg	18 pcs.	22 pcs.	10 pcs.	18 pcs.
V020-105	MSDC-1500-625	1,500 × 625	-	0.94	0.94	12.2 m	19.2 kg	14 pcs.	27 pcs.	15 pcs.	25 pcs.
V020-106	MSDC-1500-600	1,500 × 600	-	0.90	0.90	12.2 m	18.4 kg	14 pcs.	27 pcs.	15 pcs.	25 pcs.
V020-107	MSDC-2500-625	2,500 × 625	-	1.56	1.56	20.2 m	33.8 kg	22 pcs.	42 pcs.	21 pcs.	35 pcs.
V020-108	MSDC-2500-600	2,500 × 600	-	1.50	1.50	20.2 m	30.6 kg	22 pcs.	42 pcs.	21 pcs.	35 pcs.
V020-120	MSDC-1000-625-V300	1,000 × 625	300	0.63	0.48	6.7 m	13.0 kg	10 pcs.	18 pcs.	9 pcs.	20 pcs.
V020-121	MSDC-1000-600-V300	1,000 × 600	300	0.60	0.46	6.7 m	12.5 kg	10 pcs.	18 pcs.	9 pcs.	20 pcs.
V020-122	MSDC-2000-625-V200	2,000 × 625	200	1.25	1.17	15.4 m	25.7 kg	18 pcs.	33 pcs.	25 pcs.	30 pcs.
V020-123	MSDC-2000-600-V200	2,000 × 600	200	1.20	1.12	15.4 m	24.6 kg	18 pcs.	33 pcs.	25 pcs.	30 pcs.
V020-124	MSDC-2000-625-V400	2,000 × 625	400	1.25	1.04	14.2 m	25.8 kg	18 pcs.	33 pcs.	25 pcs.	30 pcs.
V020-125	MSDC-2000-600-V400	2,000 × 600	400	1.20	1.00	14.2 m	24.8 kg	18 pcs.	33 pcs.	25 pcs.	30 pcs.
V020-126	MSDC-2000-625-V600	2,000 × 625	600	1.25	0.92	13.0 m	26.0 kg	18 pcs.	33 pcs.	25 pcs.	30 pcs.
V020-127	MSDC-2000-600-V600	2,000 × 600	600	1.20	0.88	13.0 m	24.9 kg	18 pcs.	33 pcs.	25 pcs.	30 pcs.
V020-128	MSDC-2000-625-V800	2,000 × 625	800	1.25	0.79	11.8 m	26.2 kg	18 pcs.	33 pcs.	25 pcs.	30 pcs.
V020-129	MSDC-2000-600-V800	2,000 × 600	800	1.20	0.76	11.8 m	25.1 kg	18 pcs.	33 pcs.	25 pcs.	30 pcs.
<b>ModuleExpansionPanels-Classic</b>											
V021-100	MAC-2000-625	2,000 × 625	-	1.25	-	-	27.1 kg	18 pcs.	33 pcs.	25 pcs.	30 pcs.
V021-101	MAC-2000-600	2,000 × 600	-	1.20	-	-	26.0 kg	18 pcs.	33 pcs.	25 pcs.	30 pcs.
V021-102	MAC-1000-625	1,000 × 625	-	0.63	-	-	13.6 kg	10 pcs.	18 pcs.	9 pcs.	20 pcs.
V021-103	MAC-1000-600	1,000 × 600	-	0.60	-	-	13.0 kg	10 pcs.	18 pcs.	9 pcs.	20 pcs.
V021-128	MAC-1500-625	1,500 × 625	-	0.94	-	-	20.4 kg	14 pcs.	27 pcs.	15 pcs.	25 pcs.
V021-129	MAC-1500-600	1,500 × 600	-	0.90	-	-	19.5 kg	14 pcs.	27 pcs.	15 pcs.	25 pcs.
V021-126	MAC-2500-625	2,500 × 625	-	1.56	-	-	33.9 kg	22 pcs.	42 pcs.	21 pcs.	35 pcs.
V021-127	MAC-2500-600	2,500 × 600	-	1.50	-	-	32.6 kg	22 pcs.	42 pcs.	21 pcs.	35 pcs.

🔥 In the case of fire protection requirements, except where  
test verification/certification is otherwise specified

Part No.	Product code	Dimensions (h × b), [mm]	D [mm]	R1   R2 [mm]	Panel surface [m <sup>2</sup> ]	Effective surface [m <sup>2</sup> ]	Laid pipe in panel	Weight/ panel	Required quantity dry wall screws/panel	
									Longitudinal joists	Transverse joists
<b>ModuleStandardPanels-Acoustic</b>										
V024-109	MSDA-1000-625-F06	1,000 × 625	6	25.0   16.0	0.63	0.63	8.5 m	8.4 kg	10 pcs.	9 pcs.
V024-104	MSDA-1000-625-B08	1,000 × 625	8	15.0   16.0	0.63	0.63	8.5 m	10.5 kg	10 pcs.	9 pcs.
V024-110	MSDA-1000-625-F12	1,000 × 625	12	37.5   32.0	0.63	0.63	8.5 m	12.4 kg	10 pcs.	9 pcs.
<b>ModuleExpansionPanels-Acoustic</b>										
V021-113	MAA-1000-625-F06	1,000 × 625	6	25.0   16.0	0.63	-	-	12.7 kg	10 pcs.	9 pcs.
V021-108	MAA-1000-625-B08	1,000 × 625	8	15.0   16.0	0.63	-	-	11.6 kg	10 pcs.	9 pcs.
V021-114	MAA-1000-625-F12	1,000 × 625	12	37.5   32.0	0.63	-	-	12.5 kg	10 pcs.	9 pcs.
V021-102	MAC-1000-625	1,000 × 625	-	-	0.63	-	-	13.6 kg	10 pcs.	9 pcs.

## 2.3 Variomodular pipe 11.6x1.5 Laser

### Advantages

- Fully corrosion-free
- Optimum creep behaviour
- Just as light as a plastic pipe
- 10-year guarantee with certificate
- Flexible, easy to bend, extremely stable form
- Resistant to hot water additives (inhibitors, antifreeze)
- Mirror-smooth inner surface – less pressure loss – no encrustation
- High pressure and temperature resistance (10 bar, +95 °C)
- 100 % oxygen diffusion-tight
- Low linear coefficient of expansion, low heat expansion forces
- Tested as per EN 21003 (IMA Dresden), SKZ A 397

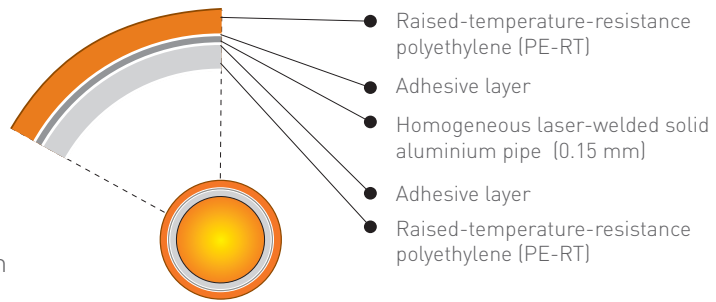

### Elongation

with 10 m and temperature difference  $\Delta t$  25 °C (e.g. 20 °C to 45 °C):

	Tubing	Elongation
Plastics	PEX (PKU)	50,00 mm
	PP	42,50 mm
	PB	32,50 mm
	PVC	20,00 mm
	Variomodular pipe	5,75 mm
Metal	Cu	4,20 mm
	Stainless steel	3,50 mm
	Steel	2,88 mm

Homogeneous plastic pipes produce high stress levels in the device because of their expansion coefficient.

The Variomodular pipe combines the minor elongation and thermal expansion. So it is perfect for surface heating- and -cooling pipes.

### Technical data

Pipe diameter:	11.6 mm
Pipe wall thickness:	1.5 mm
Aluminium pipe thickness:	0.15 mm
Water content:	0.058 l/m
Special narrow bending radius (use a suitable bending device):	30 mm
Max. operating temperature:	$t_{max} = 95 \text{ °C}$
Short-term resistant:	$t_{mat} = 110 \text{ °C}$
Max. operating pressure:	$p_{max} = 10 \text{ bar}$
Linear expansion coefficient:	$2.3 \times 10^{-5} \text{ [K}^{-1}\text{]}$
Mean heat conduction coefficient:	$\lambda = 0.43 \text{ W/mK}$
Heat transmission resistance:	$R_{\lambda} = 0.0033 \text{ m}^2\text{K/W}$

### Creep behaviour

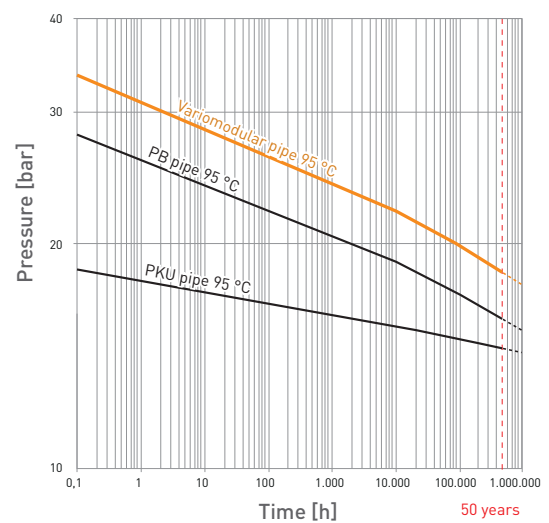

# 3 FIRE PROTECTION

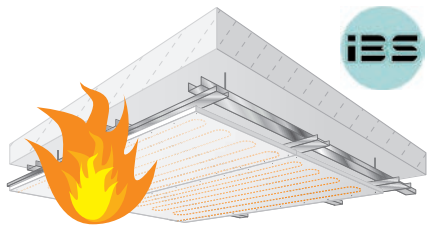

From a fire protection perspective, the 18 mm Variotherm ModulePanels correspond to a 12.5 mm FERMACELL gypsum fibreboard panel (Test IBS-Linz No. VFA2001-0389.01, fire protection assessment file number 10111710). Please observe the corresponding FERMACELL regulations and FERMACELL fire protection assessments. (Does not apply to ModuleStandard-Panels-Acoustic).

**IBS-INSTITUT FÜR BRANDSCHUTZTECHNIK UND SICHERHEITSFORSCHUNG**  
 GESELLSCHAFT M.B.H.

**Verkehrsmittel Heizsysteme GmbH**  
 Herrn Ing. Thomas Baumgartner  
 Gürteldorfer Strasse 3a  
 A- 2544 Leobersdorf

Datum: 17. November 2010  
 Aktennummer: **10111710**  
 Bearbeiter: Dipl.-Ing. (FH) U. Stöckl / hoes  
 Evt: 872

**Brandschutztechnische Beurteilung, Aktennummer: 10111710**  
**Brandversuche entsprechend EN 1364, Teil 1 sowie EN 1365, Teil 2 sowohl eines unbelasteten Wandelementes als auch eines tragenden Deckenelementes der Firma Variotherm Heizsysteme GmbH**

Aufgrund der in der Prüfstelle IBS Linz durchgeführten Brandprüfungen wird bestätigt, dass sowohl ein unbelastetes Wandelement als auch ein tragendes Deckenelement der Firma Variotherm Heizsysteme GmbH die Prüfanforderungen entsprechend EN 1364, Teil 1 sowie EN 1365, Teil 2 erfüllen.

Die Variotherm Modulplatten bestehend aus einer 18 mm Fermacell-Platte mit eingelegtam Mehrschichtverbundrohr 11,6 x 1,5/Alu 0,20 mm wurden zwei Brandprüfungen unterzogen:

- 1.) Brandversuch einer **nichttragenden Wand** nach EN 1363-1 und EN 1364-1  
 Prüfbericht Nr.: 10050617  
 Prüfdatum: 31.08.2010  
 Prüfdauer: 45 Minuten und 20 Sekunden  
 Nach EN 13501-2 Kapitel 7 5.2 in die Feuerwiderstandsklasse **EI 45** einzuordnen  
 Der Brandversuch vom 31.08.2010 am IBS Linz wurde dem Versuch mit der Prüfbericht Nr.: PG10934 vom 12.04.2002 am Danish Institute of Fire and Security Technology nachgestellt, bei dem eine Versuchszeit von 35 Minuten erreicht wurde.
- 2.) Brandversuch eines **tragenden Deckenelementes** nach EN 1363-1 und EN 1364-2  
 Prüfbericht Nr.: 10050618  
 Prüfdatum: 28.09.2010

**IBS - Institut für Brandschutztechnik und Sicherheitsforschung Gesellschaft m.b.H.**  
 A-4017 Linz, Pöchlingerstr. 40, Postfach 27  
 Akkreditierte Prüf- und Inspektionsstelle

Bauakten-Nr.: 10111710  
 Datum: 17.11.2010  
 Seite 2 von 2  
 Auftraggeber: VARIOTHERM

Prüfdauer: 100 Minuten und 20 Sekunden  
 Nach EN 13501-2 Kapitel 7 3.3 in die Feuerwiderstandsklasse **REI 60** einzuordnen  
 Der Brandversuch vom 28.09.2010 am IBS Linz wurde dem Versuch mit der Prüfbericht Nr.: MA30-VFA 2002-2173.01 vom 14.04.2003 bei der Magistratsabteilung 39 der Versuchs- und Forschungsanstalt der Stadt Wien nachgestellt, bei dem eine Versuchszeit von 94 Minuten erreicht wurde.

**Brandschutztechnische Beurteilung**

Die Brandversuche, die am IBS durchgeführt wurden waren im Aufbau ident mit jenem Brandversuchen, die in den oben angeführten Prüfanstalten durchgeführt wurden, jedoch mit dem Unterschied, dass die feuerzugewandten 12,5 mm dicken Fermacell-Platten durch 18 mm dicke Variotherm Modulplatten ersetzt wurden.

Aufgrund der vorliegenden Versuchsergebnisse nach ÖNORM EN 1364, Teil 1 sowie ÖNORM EN 1365, Teil 2 kann festgestellt werden, dass mit den 18 mm dicken Variotherm Modulplatten mindestens gleiche Ergebnisse erreicht wurden, wie mit den 12,5 mm dicken Fermacell-Platten, weshalb eine direkte Vergleichbarkeit vorliegt.

Somit kann bestätigt werden, dass in Leichtbaukonstruktionen (Wände, Decken, Dachstuhltragern), die üblichen 12,5 mm dicken Fermacell-Platten durch 18 mm dicke Variotherm Modulplatten ersetzt werden dürfen, ohne dadurch Nachteile hinsichtlich des Feuerwiderstandes zu erhalten.

**IBS - INSTITUT FÜR BRANDSCHUTZTECHNIK UND SICHERHEITSFORSCHUNG GESELLSCHAFT M.B.H.**  
 Akkreditierte Prüf- und Inspektionsstelle

*Handwritten signature: Helmut Stöckl*  
 Dipl.-Ing. (FH) Ulrich STÖCKL  
 Sachbearbeiter

*Handwritten signature: Josef Kräml*  
 Ing. Josef KRÄML  
 Bereichsleiter der Prüfstelle

*Handwritten signature: Helmut Peherstorfer*  
 Dir.-Stv. Ing. Helmut PEHERSTÖRFER  
 Zeichnungsberechtigter Geschäftsführer

## Examples of fire protection fittings

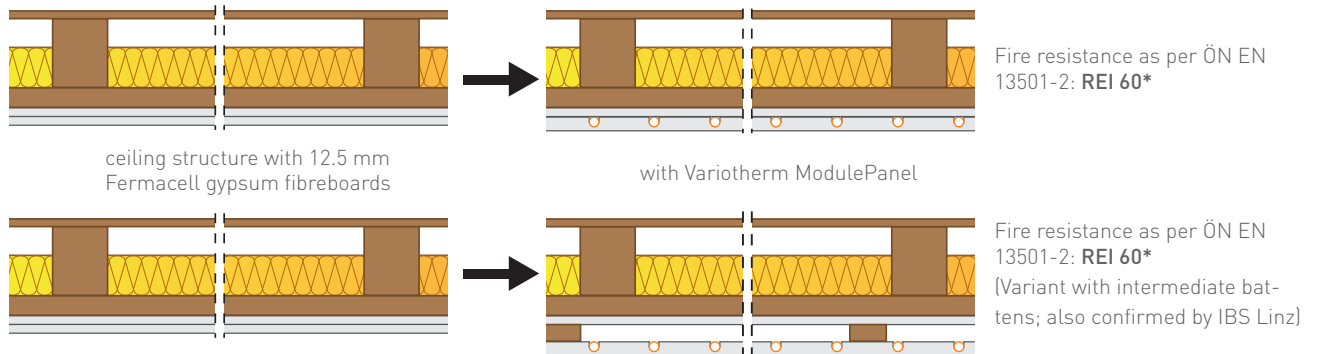

\* For details regarding wall fittings, please refer to the Fermacell planning documents.

# 4 SUBSTRUCTURE

please observe the planning and installation guidelines of the manufacturer of the wooden or drywall system used for your ceiling construction.

- With wooden constructions, the timber used must be sufficiently dry and straight, and conform to the Austrian standard DIN 4074-1 (quality class 2 and cutting class S = sharp-edged).
- With metal constructions, the profiles must be made of soft, non-alloyed steel with double-sided galvanising of at least 100 g/m<sup>2</sup> according to the Austrian standard DIN 18182-1 or DIN EN 14195.
- The construction has to be designed to carry the weight of the ModulePanels (20.5 kg/m<sup>2</sup>) and any eventual additional loads (e.g. ceiling lights). Additional loads such as ceiling lights, multi-layer planking and other fittings must also be taken into account! See also chapter 9.3.
- Do not glue the ModulePanels directly to the ceiling (plaster).

## 4.1 Dimensions in border area

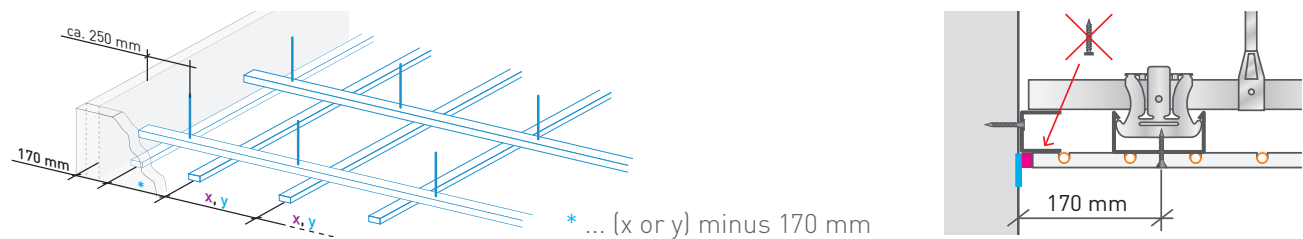

## 4.2 Wooden substructure -directly fastened base runners

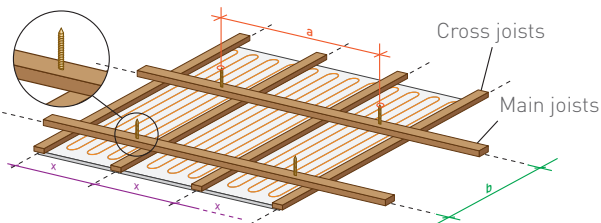

▲ Cross joists longitudinal to the ModulePanels

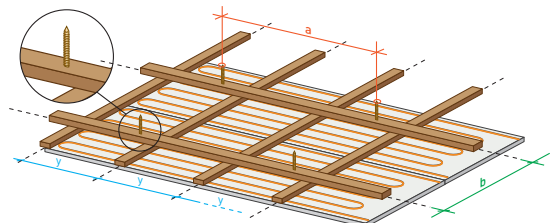

▲ Cross joists transverse to the ModulePanels

	Joist dimensions w × h [mm]	Max. permissible span for loads of up to 30 kg/m <sup>2</sup> ± ModulePanel (20.5 kg/m <sup>2</sup> ) + light additional load (up to 9.5 kg/m <sup>2</sup> )	Max. permissible span for loads of up to 50 kg/m <sup>2</sup> ± ModulePanel (20.5 kg/m <sup>2</sup> ) + heavy additional load (up to 29.5 kg/m <sup>2</sup> )
Max. clearance direct attachment (a)	Main joists 48 × 24	<b>650 mm</b>	<b>600 mm</b>
	Main joists 50 × 30	<b>750 mm</b>	<b>600 mm</b>
	Main joists 60 × 40	<b>850 mm</b>	<b>700 mm</b>
Max. axis clearance main joists (b)	Cross joists 48 × 24	<b>600 mm</b>	<b>500 mm</b>
	Cross joists 50 × 30	<b>750 mm</b>	<b>600 mm</b>
	Cross joists 60 × 40	<b>1,000 mm</b>	<b>900 mm</b>

Panel size w × b [mm]	ModuleStandardPanels-Classic									-Acoustic
	2,500 × 625	2,500 × 600	2,000 × 625	2,000 × 600	1,500 × 625	1,500 × 600	1,000 × 625	1,000 × 600	2,000 × 312	
Max. axis clearance [mm] longitudinal cross joists (x)	625.0 312.5🔥	600.0 300.0🔥	625.0 312.5🔥	600.0 300.0🔥	625.0 312.5🔥	600.0 300.0🔥	625.0 312.5🔥	600.0 300.0🔥	312.0 312.0🔥	625.0
Max. axis clearance [mm] transverse cross joists (y)	416.7 416.7🔥	416.7 416.7🔥	500.0 400.0🔥	500.0 400.0🔥	375.0 375.0🔥	375.0 375.0🔥	500.0 333.3🔥	500.0 333.3🔥	500.0 400.0🔥	500.0

🔥 In the case of fire protection requirements, except where test verification/certification is otherwise specified

### 4.3 Wooden substructure - suspended base runners

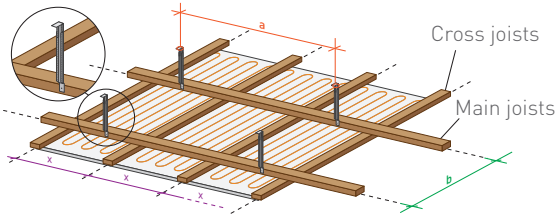

▲ Cross joists longitudinal to the ModulePanels

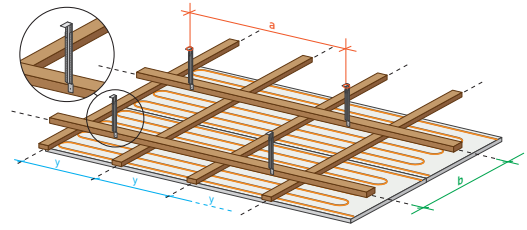

▲ Cross joists transverse to the ModulePanels

	Joist dimensions w × h [mm]	Max. permissible span for loads of up to 30 kg/m <sup>2</sup> ≙ ModulePanel (20,5 kg/m <sup>2</sup> ) + light additional load (up to 9.5 kg/m <sup>2</sup> )	Max. permissible span for loads of up to 50 kg/m <sup>2</sup> ≙ ModulePanel (20,5 kg/m <sup>2</sup> ) + heavy additional load (up to 29.5 kg/m <sup>2</sup> )
Max. clearance suspension element (a)	Main joists 30 × 50*	850 mm	700 mm
	Main joists 40 × 60	1,000 mm	850 mm
Max. axis clearance main joists (b)	Cross joists 48 × 24	600 mm	500 mm
	Cross joists 50 × 30	750 mm	600 mm
	Cross joists 60 × 40	1,000 mm	900 mm

\* Only in conjunction with cross joists that are 50 mm wide and 30 mm high

Panel size w × b [mm]	ModuleStandardPanels-Classic										-Acoustic 1,000 × 625
	2,500 × 625	2,500 × 600	2,000 × 625	2,000 × 600	1,500 × 625	1,500 × 600	1,000 × 625	1,000 × 600	2,000 × 312	1,000 × 625	
Max. axis clearance [mm] longitudinal cross joists (x)	625.0 312.5🔥	600.0 300.0🔥	625.0 312.5🔥	600.0 300.0🔥	625.0 312.5🔥	600.0 300.0🔥	625.0 312.5🔥	600.0 300.0🔥	312.0 312.0🔥	625.0	
Max. axis clearance [mm] transverse cross joists (y)	416.7 416.7🔥	416.7 416.7🔥	500.0 400.0🔥	500.0 400.0🔥	375.0 375.0🔥	375.0 375.0🔥	500.0 333.3🔥	500.0 333.3🔥	500.0 400.0🔥	500.0	

🔥 In the case of fire protection requirements, except where test verification/certification is otherwise specified

### 4.4 Metal substructure - suspended base profile

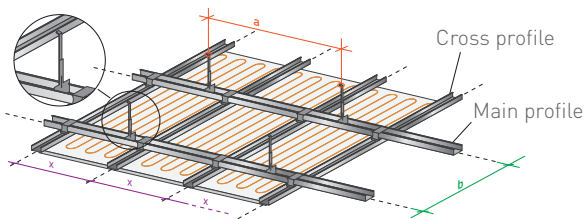

▲ Cross profiles longitudinal to the ModulePanels

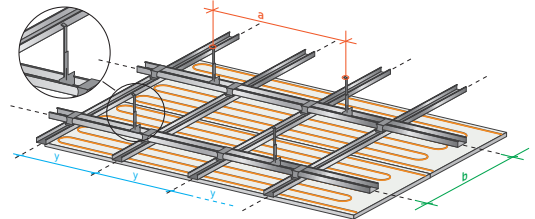

▲ Cross profiles transverse to the ModulePanels

	Profile dimensions** [mm]	Max. permissible span for loads of up to 30 kg/m <sup>2</sup> ≙ ModulePanel (20,5 kg/m <sup>2</sup> ) + light additional load (up to 9.5 kg/m <sup>2</sup> )	Max. permissible span for loads of up to 50 kg/m <sup>2</sup> ≙ ModulePanel (20,5 kg/m <sup>2</sup> ) + heavy additional load (up to 29.5 kg/m <sup>2</sup> )
Max. clearance suspension element (a)	Main profile CD 60 × 27 × 06	750 mm	600 mm
Max. axis clearance base profile (b)	Cross profile CD 60 × 27 × 06	1,000 mm	750 mm

\*\* Standard steel sheet profiles [as per ÖNORM/DIN 18182 or ÖNORM/DIN EN 14195]

Panel size w × b [mm]	ModuleStandardPanels-Classic										-Acoustic 1,000 × 625
	2,500 × 625	2,500 × 600	2,000 × 625	2,000 × 600	1,500 × 625	1,500 × 600	1,000 × 625	1,000 × 600	2,000 × 312	1,000 × 625	
Max. axis clearance [mm] longitudinal cross profile (x)	625.0 312.5🔥	600.0 300.0🔥	625.0 312.5🔥	600.0 300.0🔥	625.0 312.5🔥	600.0 300.0🔥	625.0 312.5🔥	600.0 300.0🔥	312.0 312.0🔥	625.0	
Max. axis clearance [mm] transverse cross profile (y)	416.7 416.7🔥	416.7 416.7🔥	500.0 400.0🔥	500.0 400.0🔥	375.0 375.0🔥	375.0 375.0🔥	500.0 333.3🔥	500.0 333.3🔥	500.0 400.0🔥	416.7	

🔥 In the case of fire protection requirements, except where test verification/certification is otherwise specified

#### 4.5 Directly fastened cross joists (variant without main joists)

For axis clearances of the supporting battens, see Sections 4.1 to 4.4. Due to the low construction height it is necessary to interrupt the substructure approx. 200 mm after the end of the panel. This is followed by an intermediate space of 200 mm for supply lines and/or press connections of the ModulePanels.

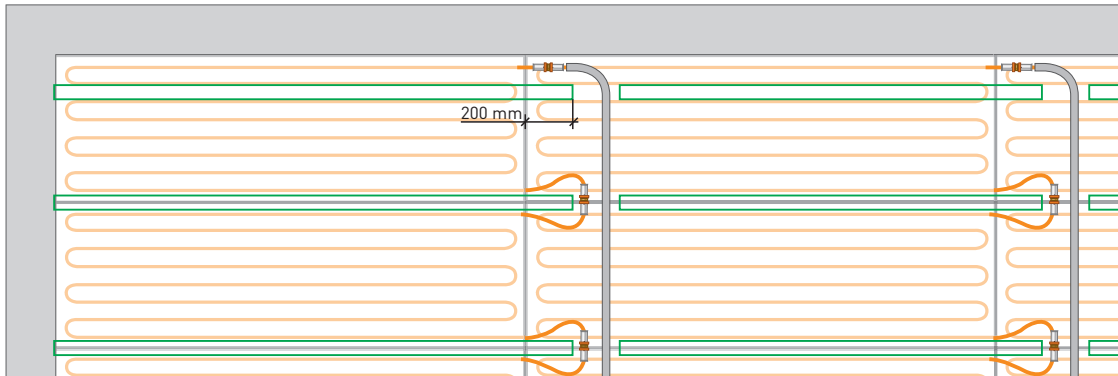

#### 4.6 Movement joints

Movement joints are to be provided every 8 m in ceiling constructions.

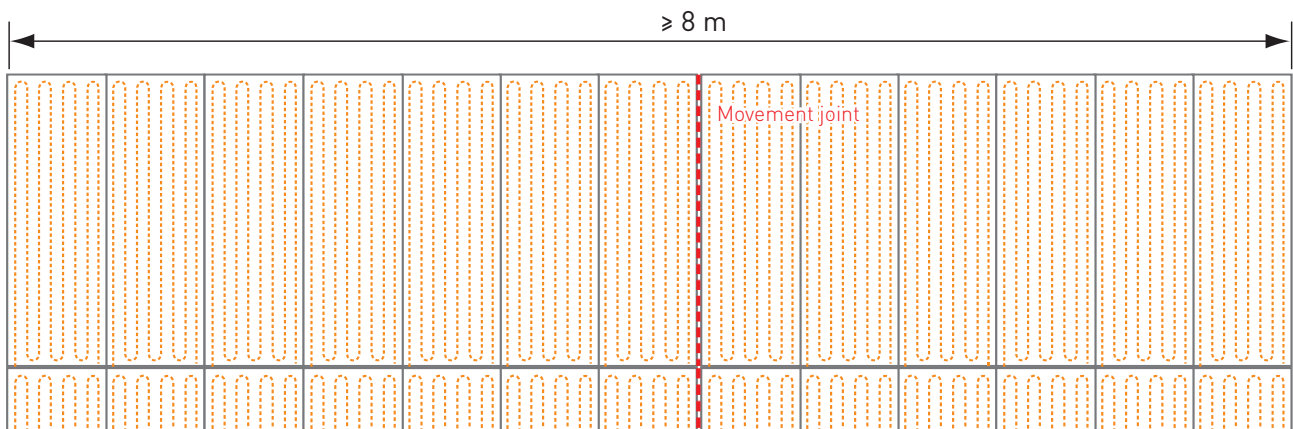

▲ Movement joint at (e.g.) 13×V020-100 (13×0.625 m = 8.13 m)

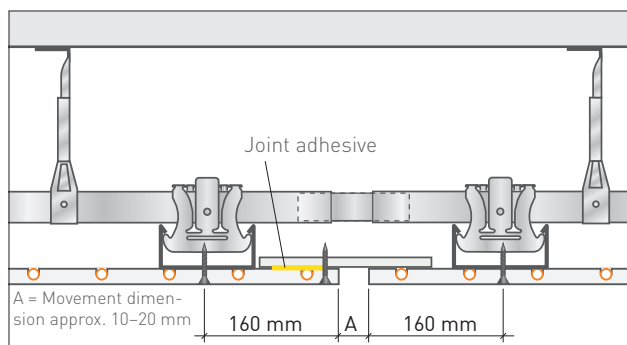

▲ Movement joint with panel strip

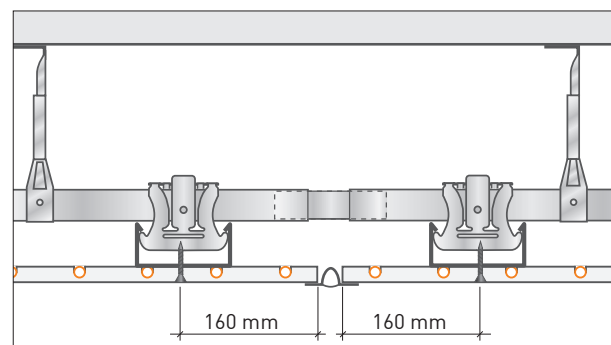

▲ Movement joint with additional profile



## 4.7 Residual areas and panel transitions

The areas at the sides of the ModuleStandardPanels are filled out using ModuleExpansionPanels (please observe the FERMACELL guidelines). These panels without pipes are also glued with joint adhesive on the front side. The width of the ModuleExpansionPanels should not be less than 200 mm.



Cross joints are to be avoided. Inner and outer corners and T-joints are to be constructed as grouted joints (approx. 7 mm) ■ with a separating layer ■ (decoupled connection).

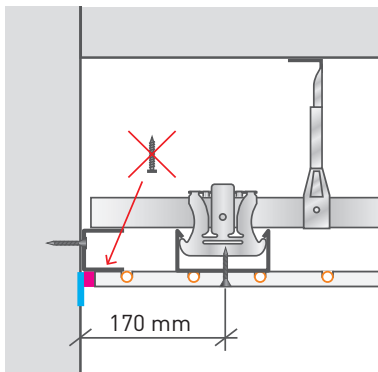

▲ Connection with separating layer

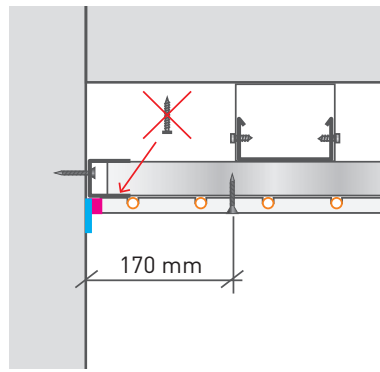

▲ Connection with separating layer

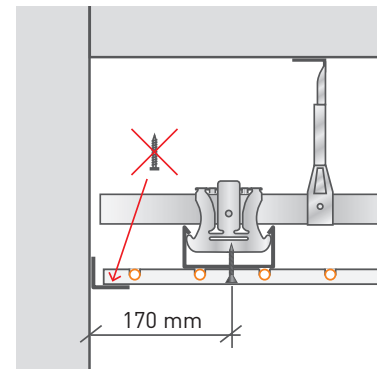

▲ Connection with angled beading

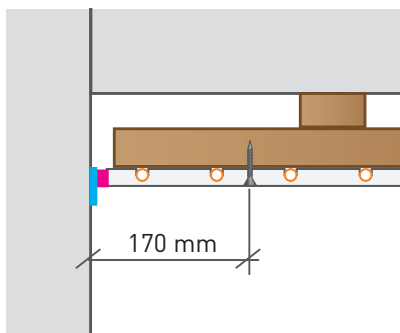

▲ Connection with separating

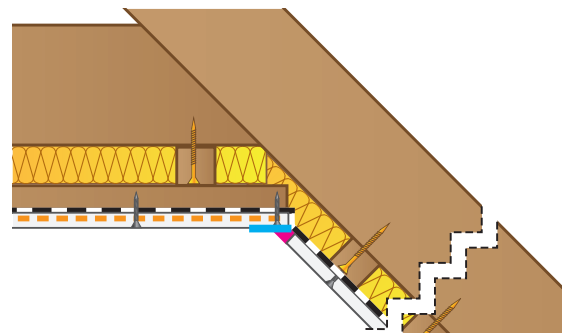

▲ ModuleStandardCeiling to roof pitch

### ModulePanel to plasterboard panels:

Variotherm provides no guarantee for transitions to products from other panel manufacturers. Please observe the specifications of the respective (panel) manufacturer.

We can however provide you with four practical examples of transition methods:

- Grouted joints (approx. 7 mm) ■ with a separating layer ■ (decoupled connection). Advantage: intentional straight crack (usually hardly visible)
- Elastic seam (acrylic mass), (maintenance seam, not suitable for fire prevention constructions)
- Fascia
- Wooden strip fastened on one side for covering the transition

# 5 COOLING/THERMAL PERFORMANCE

## 5.1 Calculation of the cooling and heating load

Variotherm also conducts cooling load calculations (subject to a fee) according to the new VDI 2078 guideline (valid since June 2013). For calculation purposes, precise information must be provided on the building and the rooms to be cooled (U-values with layer composition, shading, internal loads). This is the precondition for useful, accurate results.

The EN 12831 standard with the respective national annex applies to the heating load calculations for the heated rooms. Every room is considered individually. For the outside temperature, the locally acquired and standardised outdoor temperature  $T_{ne}$  is used.

Bezeichnung	Fläche m <sup>2</sup>	Kühllast W	Kühllast W/m <sup>2</sup>	t <sub>Raum</sub> °C	t <sub>op, Raum</sub> °C
Schlafzimmer	21.70	-1601	-73.76	24.0	23.9
Wohnen, Kochen, Essen	84.50	-2906	-34.39	24.0	24.8
Wirtschaftsraum	13.00	-455	-35.01	24.0	24.6
WC	4.60	-73	-15.89	24.0	24.1
Corridor + Stiege	29.40	-1822	-61.96	24.0	25.4
Lounge + Stiege	22.00	-459	-20.85	24.0	24.3
Küche II (Pantry)	30.50	-956	-31.35	24.0	24.8
Vorraum	10.00	-239	-23.94	24.0	24.5
Küche I (Pantry)	14.00	-414	-29.55	24.0	24.6
Gästezimmer 1	23.50	-613	-26.08	24.0	24.6
Flur + Stiege	12.40	-342	-27.59	24.0	24.6
Gästezimmer 2	28.70	-746	-25.98	24.0	24.5
<b>Summe</b>	<b>294.30</b>	<b>-10625</b>	<b>-36.10</b>		

▲ Extract from a cooling load calculation

### Übersicht der Bauteile

Code	Bezeichnung	U-Wert W/m <sup>2</sup> K	Rges m <sup>2</sup> K/W	Rsi m <sup>2</sup> K/W	Rse m <sup>2</sup> K/W	R-Baut m <sup>2</sup> K/W
AF01	Außenfenster	1,100	0,909	0,130	0,040	0,739
AT01	Außentür	1,700	0,588	0,130	0,040	0,418
AW01	Außenwand	0,220	4,545	0,130	0,040	4,375

Raum	Q <sub>int</sub>	A <sub>v</sub>	Φ <sub>te</sub>	Φ <sub>e</sub>	Φ <sub>v</sub>	Φ <sub>strahlw</sub>	Φ <sub>strahlw</sub>	Φ <sub>strahlw</sub>	Φ <sub>strahlw</sub>	Φ <sub>strahlw</sub>	Φ <sub>strahlw</sub>	
Nr.	Bezeichnung	°C	m <sup>2</sup>	W	W	W	W	W	W	W	W	
Haus, EG			180,88	5427		3396				9160	0	9160
00.001.001	Eltern	20,0	29,10	833	833	501	46	15	1335	0	1335	
00.001.002	Kinder	20,0	20,49	762	762	343	54	19	1106	0	1106	
00.001.003	Vorraum	20,0	24,40	571	571	408	40	14	980	0	980	

▲ Extract from a heating load calculation

## 5.2 Variotherm dimensioning softwares

Key values for individual cooling/heating circuits (the amount of water, pressure loss, number of circuits, allocation of the manifolds etc.) can be quickly and easily calculated by inputting the cooling or heating load into the Variotherm dimensioning softwares. It can be found in our Professional Area at [www.variotherm.com/profi](http://www.variotherm.com/profi).

Bauvorhaben: \_\_\_\_\_ PLZ: \_\_\_\_\_ Ort: \_\_\_\_\_ Datum: \_\_\_\_\_ Bearbeiter: as

Nr	Raum Bezeichnung	Raumgröße		Kühllast	Aufschlag Kühllast	Raumtemp.	Kühlsystem	Auslegungstemperatur	rechnerisch			praktisch			Zuleitung Rohr	Zuleitungslänge pro Kühlkreis [m]	Druckverlust pro Kühlkreis [mWS]	Durchflussmenge pro Kühlkreis [kg/h]	Kühlkreisverteilung	Sonderfall 2 Kühlsysteme an einem Kühlkreis (siehe Anleitung)
		A [m <sup>2</sup> ]	O [m]						Auslegung	Einl.	Typ	Anzahl Kreise	Einl.	Restleistung						
	Zimmer	21,16	1,021	0	0	26	ModulDecke MSD/MRD	16/20	17,02 m <sup>2</sup>	MSD/MRD	3	5,8 m <sup>2</sup>	23			2,61	75	•1		
	Garderobe	10,15	564	0	564	26	ModulDecke MSD/MRD	16/20	9,40 m <sup>2</sup>	MSD/MRD	2	4,5 m <sup>2</sup>	-24			1,50	59	•1		
	Zimmer	23,04	1,032	0	1,032	26	ModulDecke MSD/MRD	16/20	17,20 m <sup>2</sup>	MSD/MRD	3	5,8 m <sup>2</sup>	12			2,61	75	•1		
	Gang		335	0	335	26	ModulDecke MSD/MRD	16/20	5,99 m <sup>2</sup>	MSD/MRD	1	6 m <sup>2</sup>	25			2,90	78	•1		
	Wohnküche	33,14	1,543	0	1,543	26	ModulDecke MSD/MRD	16/20	25,72 m <sup>2</sup>	MSD/MRD	5	5,4 m <sup>2</sup>	77			2,15	70	•1		
	Wohnküche und Gang	46,00	1,754	0	1,754	26	ModulDecke MSD/MRD	16/20	29,24 m <sup>2</sup>	MSD/MRD	5	6,2 m <sup>2</sup>	106			3,20	81	•2		
	Zimmer	26,04	1,245	0	1,245	26	ModulDecke MSD/MRD	16/20	20,75 m <sup>2</sup>	MSD/MRD	4	5 m <sup>2</sup>	-45			1,75	65	•2		
	Zimmer	17,08	954	0	954	26	ModulDecke MSD/MRD	16/20	15,90 m <sup>2</sup>	MSD/MRD	3	5 m <sup>2</sup>	-54			1,75	65	•2		

Menge	Einheit	Kühlsystem	Rohr
142,8	m <sup>2</sup>	ModulDeckenkühlung MSD/MRD	1.999,2 lfm
	m <sup>2</sup>	System-Wandkühlung SWHK2	
	m <sup>2</sup>	System-Wandkühlung SWHK3	
	m <sup>2</sup>	Modul-Wandkühlung MSW	
	m <sup>2</sup>	EasyFlex-Wandkühlung EWHK77	
	m <sup>2</sup>	EasyFlex-Wandkühlung EWHK115	
	m	Zuleitung 10x2	
	m	Zuleitung 11,6x1,5	
		<b>Summe Füllwasser</b>	<b>116,0 Liter</b>

Zelle	Raum	m 8 16	m 8 11,6	Zelle	Raum	m 8 16	m 8 11,6
1	Zimmer	243,6	14	15	Zimmer	210,0	
2			16				
3	Garderobe	126,0	16				
4			17				
5	Zimmer	243,6	18				
6			19				
7	Gang	84,0	20				
8			21				
9	Wohnküche	378,0	22				
10			23				
11	Wohnküche und	434,0	24				
12			25				
13	Zimmer	280,0		<b>SUMME</b>		<b>1.999,2</b>	

	tlwr	Anzahl der Kühlkreise	Durchflussmenge [kg/h]	Max. Druckverlust +0,1 mWS für Verteiler [mWS]	Verteilerzuordnung lt. Plan
Kühlkreisverteiler #1	16/20	14	956	3,30	A
Kühlkreisverteiler #2	16/20	12	860	3,30	B
Kühlkreisverteiler #3					
Kühlkreisverteiler #4					
Kühlkreisverteiler #5					
Bei Anpassung aller Kühlkreisverteiler über eine Pumpe gilt:					
Gesamtdurchflussmenge:			1856	kg/h	
Maximaler Druckverlust ab Kühlkreisverteiler inkl. D,1 mWS für max. geöffnetes Ventil			3,30	mWS	

▲ Variotherm dimensioning software example for cooling

### 5.3 Cooling performance

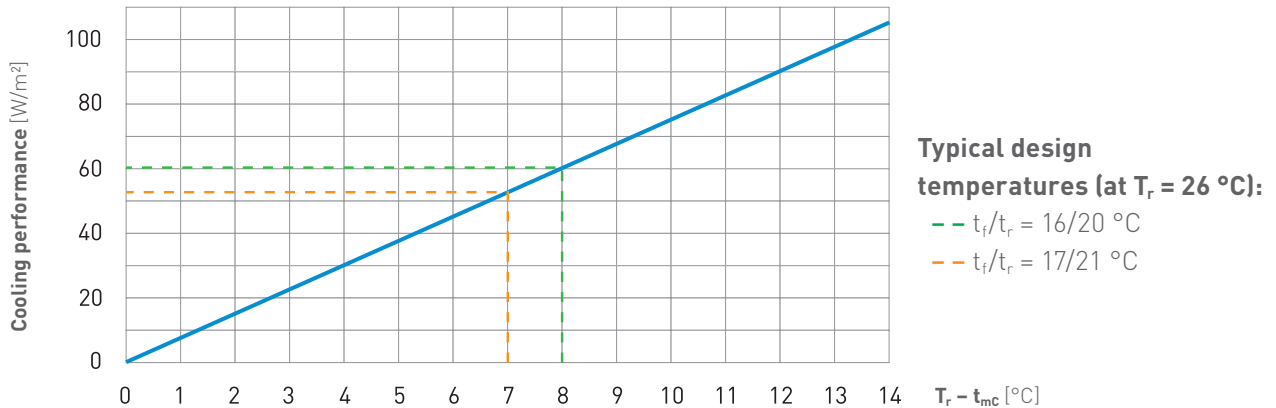

The surface temperature must not reach or fall below the dew point temperature!  
 The mean surface temperature  $T_0$  corresponds approximately to the return temperature  $t_r$ .

Relative humidity [%rH]	Room temperature [ $T_r$ ]				
	24 °C	25 °C	26 °C	27 °C	28 °C
70 %	18.0	19.0	20.0	21.0	22.0
60 %	15.5	16.5	17.5	18.5	19.2
50 %	13.0	14.0	15.0	15.8	16.8
40 %	9.8	10.5	11.5	12.5	13.2

$$t_{mc} = \text{mean cooling water temperature} = \frac{t_f + t_r}{2} \text{ [°C]}$$

$T_0$  = mean surface temperature [°C]

$T_r$  = room temperature [°C]

$t_f/t_r$  = flow temperature / return temperature [°C]

### 5.4 Heat output tables

Chart valid with ceiling height 2.5–3.5 m.

**Do not exceed  $t_{mH} = 35\text{ °C}$  ( $t_f/t_r = 40/30\text{ °C}$ ) because of reasons of comfort!**

$t_f/t_r$ [°C]	$t_{mH}$ [°C]	Heat output [W/m <sup>2</sup> ] at room temperature ...					$T_0$ [°C] (at $T_r = 20\text{ °C}$ )
		... 15 °C	... 18 °C	... 20 °C	... 22 °C	... 24 °C	
30/20	25.0	55	39	27	15	-	27
30/25	27.5	68	54	41	28	15	28
35/25	30.0	82	67	55	42	28	29
35/28	31.5	90	75	62	49	36	30
35/30	32.5	96	81	68	55	42	31
37.5/32.5	35.0	110	95	82	69	55	32
40/30	35.0	110	95	82	69	55	32

$$t_{mH} = \text{mean hot water temperature} = \frac{t_f + t_r}{2} \text{ [°C]}$$

$T_0$  = mean surface temperature [°C]

$T_r$  = room temperature [°C]

$t_f/t_r$  = flow temperature / return temperature [°C]

# 6 PIPING

## Example of ModuleStandardCeiling (cooling case)

e.g. TOUCH HK

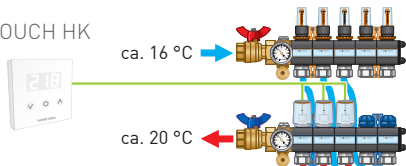

Distribution manifolds can also be mounted on the ceiling.

Supply pipes: pre-insulated Variomodular pipes 16x2 Laser

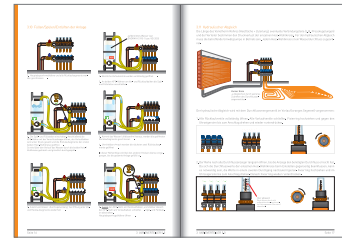

▲ Details regarding the system and heating circuit pipes and the room temperature control are provided in the DISTRIBUTION and CONTROL design and installation manual

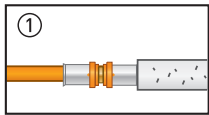

Press-fit coupling 16x11,6

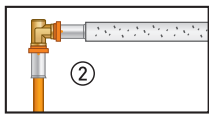

Press-fit brackets 90° 16x11,6

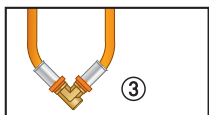

Press-fit brackets 90° 11,6x11,6

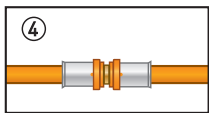

Press-fit coupling 11,6x11,6

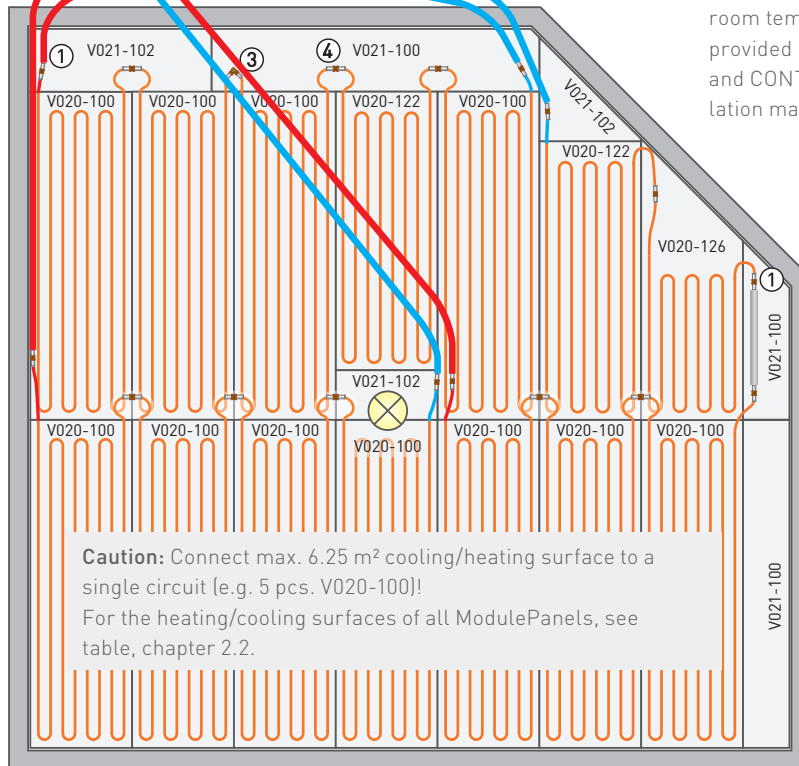

**Caution:** Connect max. 6.25 m<sup>2</sup> cooling/heating surface to a single circuit (e.g. 5 pcs. V020-100)!  
For the heating/cooling surfaces of all ModulePanels, see table, chapter 2.2.

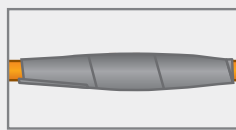
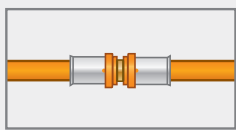

### Corrosion protection measures:

According to ÖN H 5155, the joints should be protected after the pressure test (e.g. using cold shrink tape or corrosion protection tape).

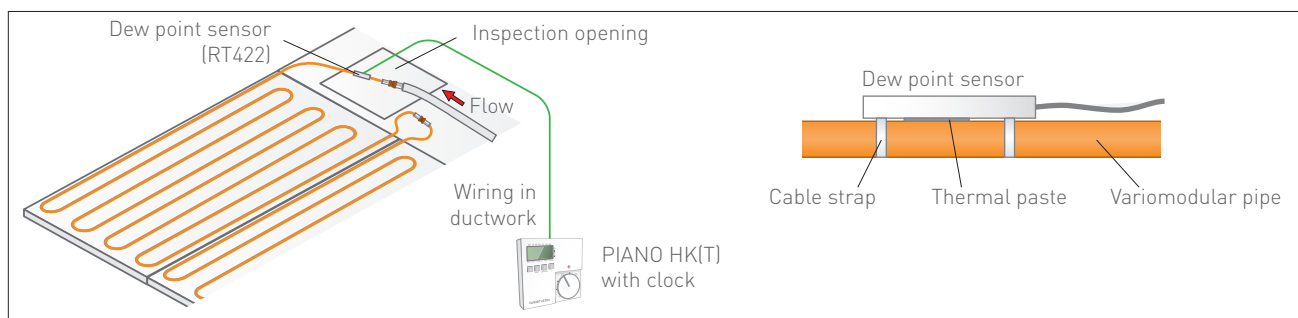

▲ Dew point sensor example

# 7 ARRANGEMENT OF THE SURFACES

Ceilings and pitched roofs are ideally suited for use as cooling and heating surfaces because the radiant surfaces are not impeded by room furnishings.

Experience has shown that the comfort effect is perceived at a distance of up to 3.5 m from the thermally active ceiling. In higher rooms it is therefore advantageous to suspend the ceiling because the radiance effect on the body declines in proportion to the square of the distance.

Estimated values for dimensions:

- 70–80 % ceiling surface of the room area for cooling
- 50–60 % ceiling surface of the room area for heating

**Caution:** Observe the heating/cooling load calculation for precise dimensioning of the area required!

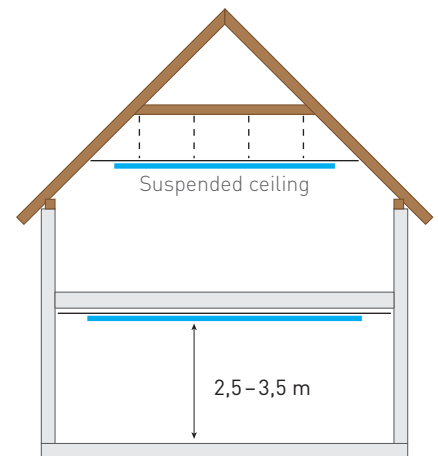

## ModuleStandardCeiling as “ceiling element”

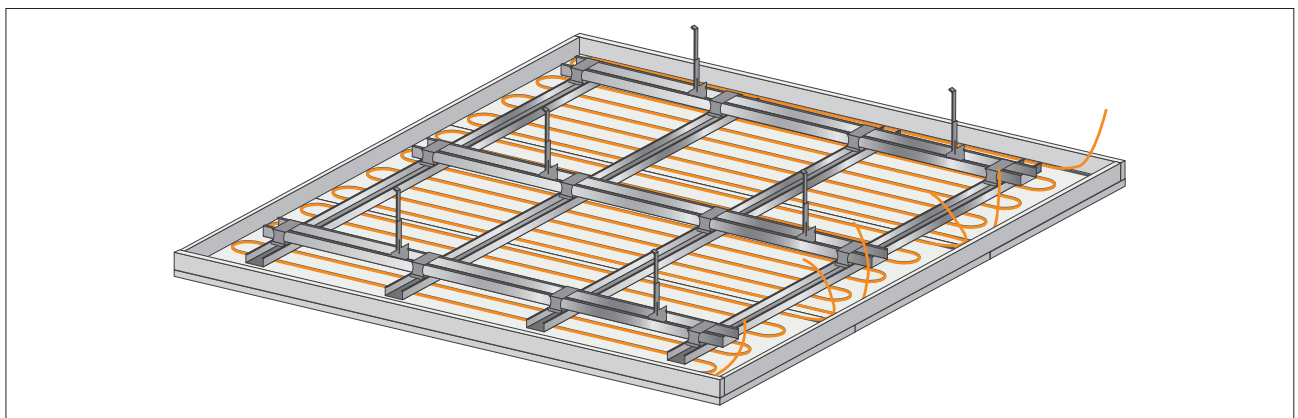

▲ Ceiling element example

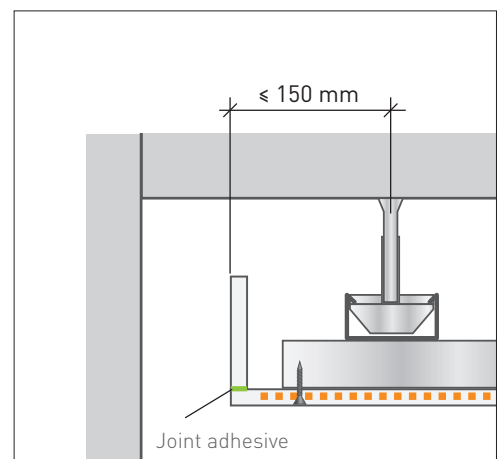

# 8 PRESSURE LOSS

Example: The total pressure loss  $\Delta p_{\text{Total}}$  of a 6.25 m<sup>2</sup> ModulCeiling (5 pcs. V020-100 at 1 cooling circuit) is to be calculated. The desired flow/return temperature is 16/20 °C, resulting in a heat output of 60 W/m<sup>2</sup> at a room temperature of 26 °C.

The total pressure loss  $\Delta p_{\text{total}}$  is calculated using the following components:

- Pipes and press-fit couplings
- Heating/cooling distribution manifold
- Boiler house (mixing valve, boiler ...)

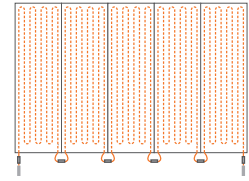

## 1.) Pipes and press-fit couplings

Calculation of the flow rate  $\omega$  from the pressure loss diagram:  
 $Q = 375 \text{ W}$  ( $60 \text{ W/m}^2 \times 6.25 \text{ m}^2$ )  
 $\Delta T = 4 \text{ K}$  ( $t_r/t_i = 16/20 \text{ °C}$ )  
 $\text{Flow volume } m = Q / c / \Delta T = 375 \text{ W} / 1.163 \text{ Wh/kgK} / 4 \text{ K} = 80.6 \text{ kg/h}$   
 A flow volume  $m = 80.6 \text{ kg/h}$  (= l/h) yields a flow rate  $\omega = 0.4 \text{ m/s}$

Pipe length in ModulePanel (see table chapter 2.2)		
V020-100	MSDC-2000-625	16.2 m
Press-fit coupling	Coefficient of resistance $\zeta$ [Zeta]	
16 x 11.6	6.9	
11.6 x 11.6	7.2	
Density of water $\rho$ (Rho)		1,000 kg/m <sup>3</sup>
Specific heat capacity of water c		1.163 Wh/kgK

- $\Delta p$  for 15 m pre-insulated Variomodular pipe 16x2:  $60 \text{ Pa/m} \times 15 \text{ m} = 900 \text{ Pa}$
- $\Delta p$  for 6.25 m<sup>2</sup> ModulPanels (5 pcs. V020-100):  $342 \text{ Pa/m} \times [5 \text{ pcs.} \times 16.2 \text{ m} = 81 \text{ m}] = 27,702 \text{ Pa}$
- $\Delta p$  for 4 pcs. press-fit couplings 11.6x11.6:  $\zeta \times \rho/2 \times \omega^2 = 7.2 \times 500 \text{ kg/m}^3 \times (0.4 \text{ m/s})^2 = 576 \text{ Pa} \times 4 \text{ pcs.} = 2,304 \text{ Pa}$
- $\Delta p$  for 2 pcs. press-fit couplings 16x11.6:  $\zeta \times \rho/2 \times \omega^2 = 6.9 \times 500 \text{ kg/m}^3 \times (0.4 \text{ m/s})^2 = 552 \text{ Pa} \times 2 \text{ pcs.} = 1,104 \text{ Pa}$

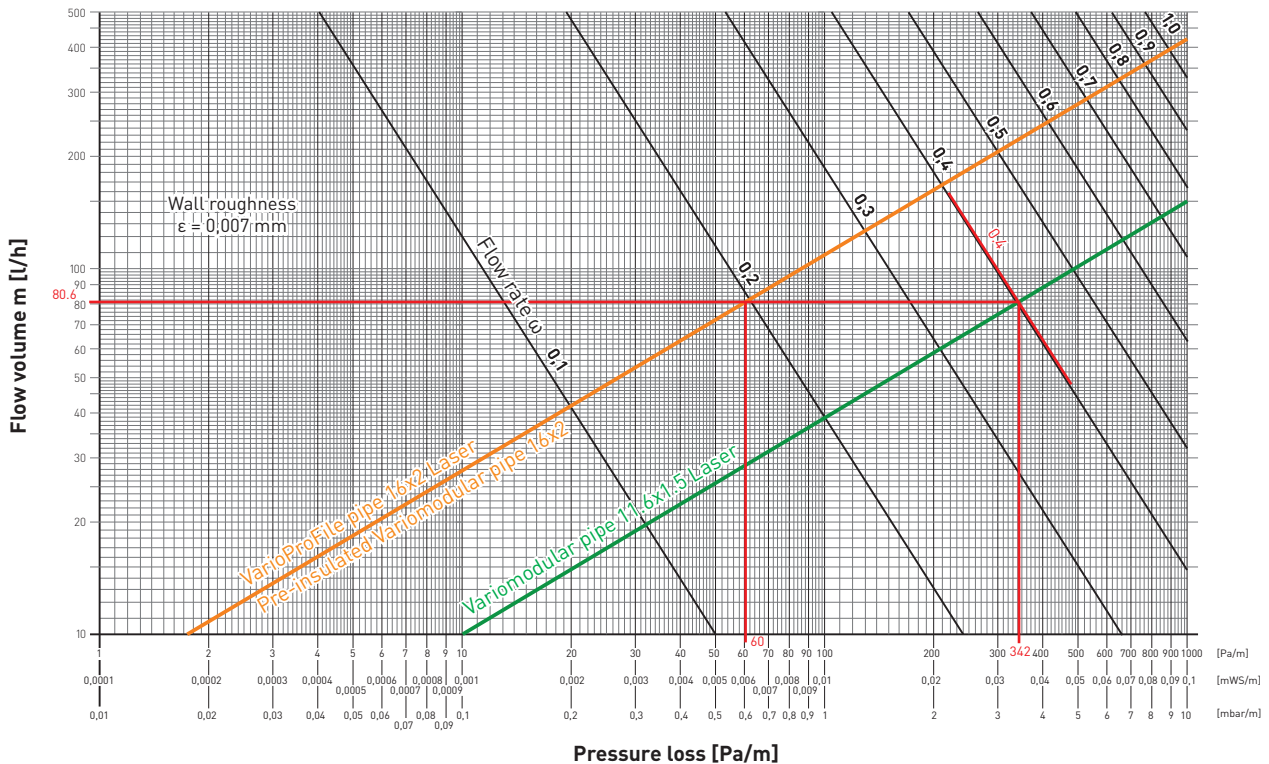

## 2. Heating/cooling distribution manifold

The flow rate characteristic curves for calculating the pressure loss of the heating/cooling distribution manifold for the heating circuits in question.

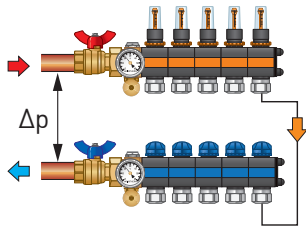

- $\Delta p$  of the heating/cooling distribution manifold with an open valve up to  $80.6 \text{ l/h} = 900 \text{ Pa}$

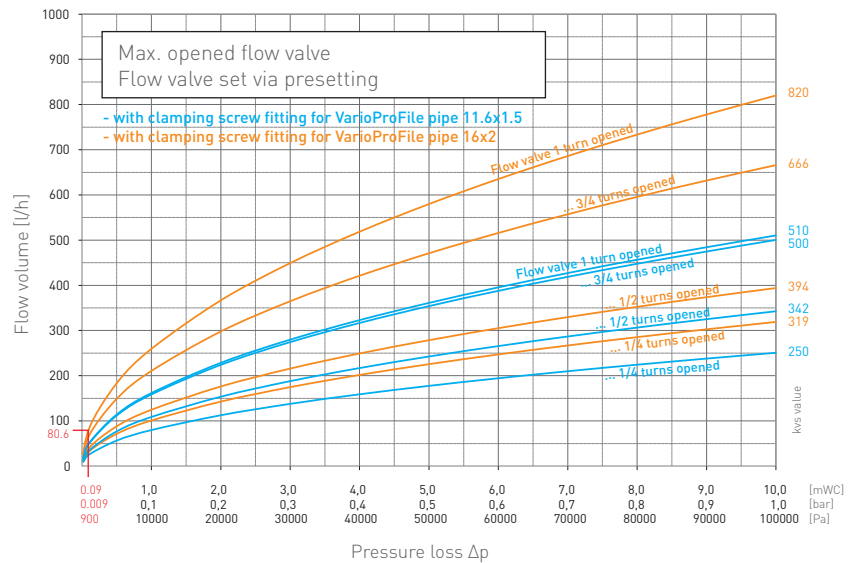

## 3. Boiler house (assumptions)

- $\Delta p$  Mixing valve = 6,000 Pa
- $\Delta p$  Connection piping = 3,500 Pa
- $\Delta p$  Boiler = 3,000 Pa

## 4. Total pressure

- $\Delta p_{\text{total}} = 45,410 \text{ Pa} = 4.5 \text{ mWC}$

## 5.) Selection of the heating circulation pump (example: Wilo Yonos PICO Plus 25/1-6)

At the calculated pressure loss of 4.5 mWC the pump supplies a maximum volume flow of  $1.3 \text{ m}^3/\text{h}$ .

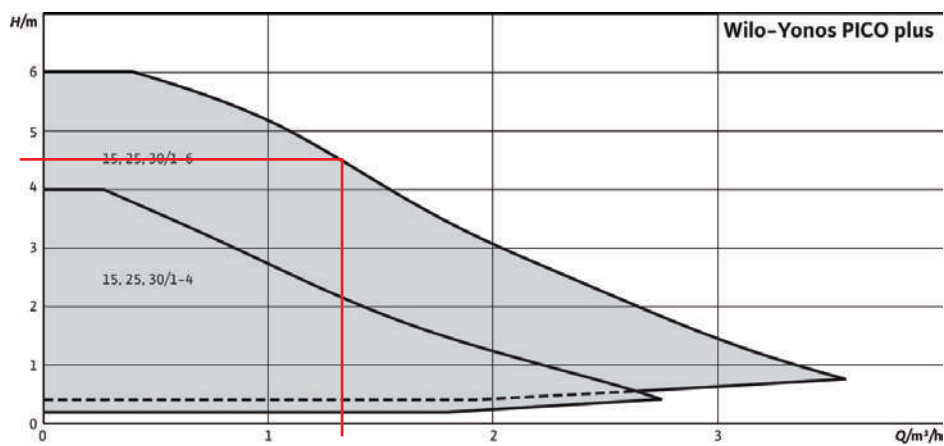

- ▲ Example: Wilo Yonos PICO Plus 25/1-6 heating circulation pump

# 9 FINISHED SURFACE

## 9.1 Stopping

**Caution:** Stopping must not be performed until all wet work has dried out (wet screed, plastering work, etc.)! After installation, the ModulePanels and the ModuleExpansionPanels are stopped using FERMACELL grouting or fine stopper.

The following work is to be performed, depending on the surface quality required:

<b>Q1</b>	• Stopping of visible joints and adhesive seams with FERMACELL grouting
<b>Q2</b>	• Q1 + burr-free and step-free stopping of the seams and joints
<b>Q3</b>	<u>Full-surface stopping:</u> <ul style="list-style-type: none"> <li>• Stopping of the visible joints with FERMACELL grouting or plaster</li> <li>• Wide stopping of the seams</li> <li>• Full-surface coating and sharp pulling-off using FERMACELL grouting or fine stopper or other suitable stopping material</li> </ul>
<b>Q4</b>	<u>Full-surface coating:</u> <ul style="list-style-type: none"> <li>• Stopping of the visible joints with FERMACELL grouting or plaster</li> <li>• Wide stopping of the seams</li> <li>• Full-surface coating and smoothing using FERMACELL fine stopper or plaster or other suitable stopping material</li> </ul>

## 9.2 Painting

Commonly available paints such as e.g. latex, emulsion or enamel paint can be applied to the ModulePanels. Mineral-based paints such as e.g. limewash and silicate paints must be approved by the manufacturer for use on gypsum fibre boards. The paint is usually applied in two steps.

## 9.3 Fastening loads to the ModuleCeiling

Low “static” loads can be fixed directly on the ModuleCeiling as prescribed by the following table (Do not damage the Variomodular pipes!):

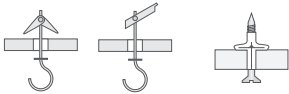
Fixing components - Observe the instructions of the dowel manufacturer!	Permissible single loads for individual hanging on ModulePanel (dowel distance $\geq$ 300 mm)	Max. permissible area load per m <sup>2</sup> ModulePanel (dowel distance $\geq$ 300 mm)
	2 kg	6 kg

**Heavier suspended elements** must only be attached to the substructure and not to the ModulePanels. Additional loads must be designed for the substructure (see max. permissible span, chapter 4).



# 10 ACOUSTIC

## 10.1 General

Variotherm also offers ModulePanels with sound absorbent properties that significantly reduce the sound levels in living areas and offices. The holes in the gypsum fibre boards channel the impinging sound waves through the panel, where the sound energy is then “broken” and dispersed in the ceiling structure.

**A special detail:** With the Variotherm ceiling cooling/heating system, the holes of the acoustic panels are not covered by cooling/heating elements and thus remain 100 % active. This allows a tested and guaranteed sound reduction to be achieved.

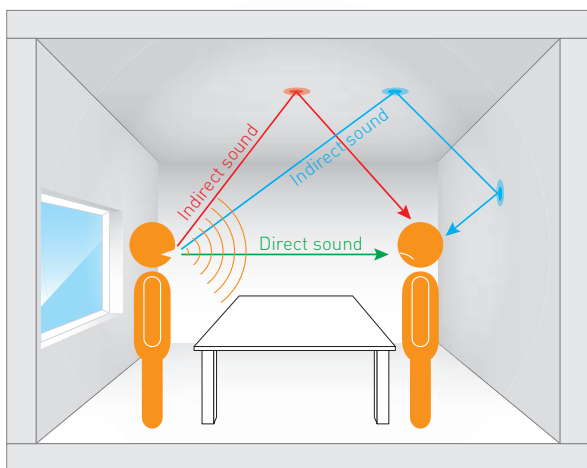

▲ Acoustic reflection

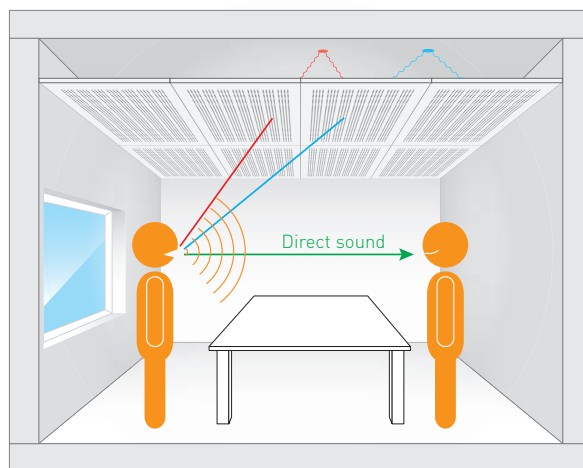

▲ Acoustic reflection with ModulePanel-Acoustic

The room acoustics calculator at “[www.trikustik.at/rak-rechner](http://www.trikustik.at/rak-rechner)” allows easy optimisation of room acoustics and allows individual adjustment of various different parameters according to their use.

## 10.2 Panel variants

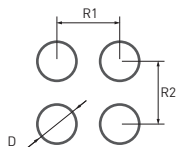
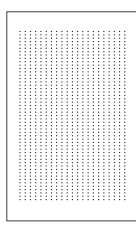
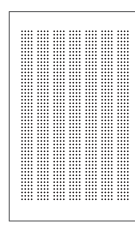
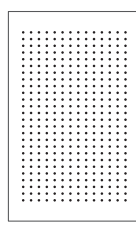
	F06	B08	F12
			
<b>Hole diameter (D):</b>	6 mm	8 mm	12 mm
<b>Hole spacing (R1):</b>	25.0 mm	15.0 mm	37.5 mm
<b>Hole spacing (R2):</b>	16.0 mm	16.0 mm	32.0 mm
<b>Hole percentage:</b>	4.8 %	12.4 %	6.6 %
<b>Delivery time:</b>	on stock	on stock	on stock
<b>Hole pattern:</b>	Continuous holes	Block holes	Continuous holes
<b>Panel material:</b>	Gypsum fibreboard which has been tested for their healthy building properties, 18 mm		
<b>Panel size:</b>	1,000 × 625 mm		
<b>Pipe:</b>	Variomodular pipe 11.6x1.5 Laser		
<b>Rear side:</b>	Acoustic fleece AV 100, black		

### 10.3 Acoustic values

# B08

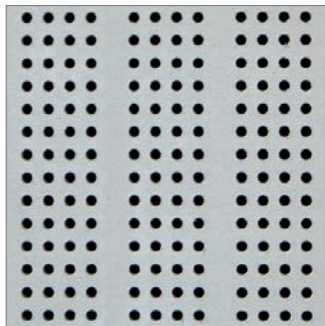

Tested by TÜV Rheinland per DIN EN ISO 354

**Data source:** LGA/TÜV Rheinland Certificate  
**Test number:** 84129010  
**Valid for:** Ceiling  
**Fleece:** AV 100  
**Insulation:** Rockwool Sonorock or equivalent

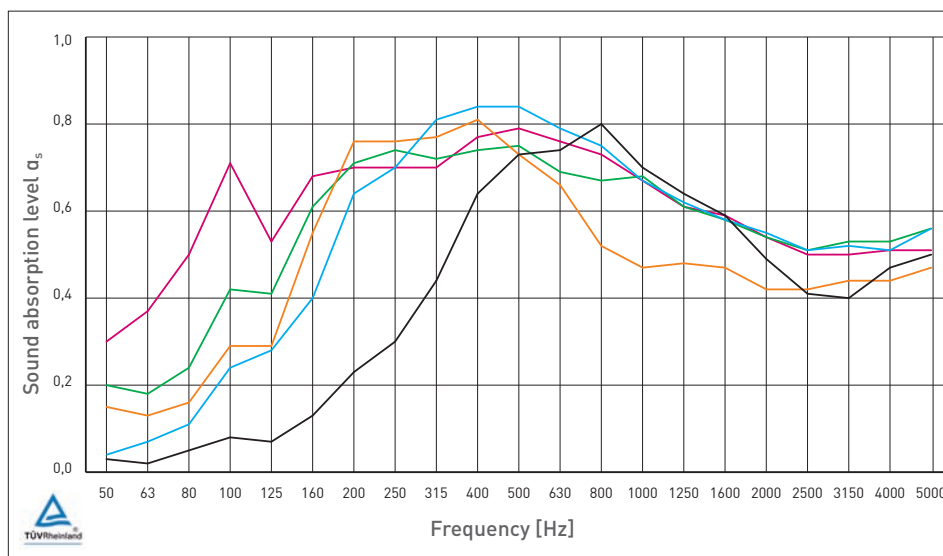

Black line	H = 70 mm, H <sub>D</sub> = 0 mm
Blue line	H = 70 mm, H <sub>D</sub> = 50 mm
Orange line	H = 200 mm, H <sub>D</sub> = 0 mm
Green line	H = 200 mm, H <sub>D</sub> = 50 mm
Pink line	H = 200 mm, H <sub>D</sub> = 180 mm

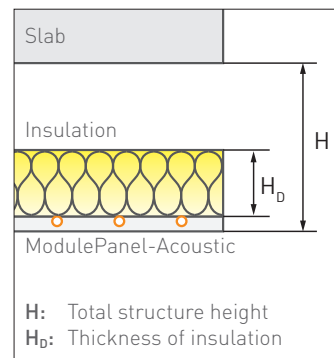

	Hz	50	63	80	100	125	160	200	250	315	400	500	630	800	1000	1250	1600	2000	2500	3125	4000	5000	
H = 70 mm H <sub>D</sub> = 0 mm	$\alpha_s$	0.03	0.02	0.05	0.08	0.07	0.13	0.23	0.30	0.44	0.64	0.73	0.74	0.80	0.70	0.64	0.59	0.49	0.41	0.40	0.47	0.50	$\alpha_w$ : 0.55
	$\alpha_p$					0.10		0.30		0.70		0.70		0.70		0.50		0.45		0.45			AC: D
H = 70 mm H <sub>D</sub> = 50 mm	$\alpha_s$	0.04	0.07	0.11	0.24	0.28	0.40	0.64	0.70	0.81	0.84	0.84	0.79	0.75	0.67	0.62	0.58	0.55	0.51	0.52	0.51	0.56	$\alpha_w$ : 0.65 (L)
	$\alpha_p$				0.30		0.70		0.80		0.70		0.55		0.55		0.55		0.55		0.55		AC: C
H = 200 mm H <sub>D</sub> = 0 mm	$\alpha_s$	0.15	0.13	0.16	0.29	0.29	0.55	0.76	0.76	0.77	0.81	0.73	0.66	0.52	0.47	0.48	0.47	0.42	0.42	0.44	0.44	0.47	$\alpha_w$ : 0.50 (LM)
	$\alpha_p$				0.40		0.75		0.75		0.75		0.50		0.45		0.45		0.45		0.45		AC: D
H = 200 mm H <sub>D</sub> = 50 mm	$\alpha_s$	0.20	0.18	0.24	0.42	0.41	0.61	0.71	0.74	0.72	0.74	0.75	0.69	0.67	0.68	0.61	0.58	0.54	0.51	0.53	0.53	0.56	$\alpha_w$ : 0.65 (L)
	$\alpha_p$				0.50		0.70		0.75		0.75		0.65		0.55		0.55		0.55		0.55		AC: C
H = 200 mm H <sub>D</sub> = 180 mm	$\alpha_s$	0.30	0.37	0.50	0.71	0.53	0.68	0.70	0.70	0.70	0.77	0.79	0.76	0.73	0.67	0.61	0.59	0.54	0.50	0.50	0.51	0.51	$\alpha_w$ : 0.60 (L)
	$\alpha_p$				0.65		0.80		0.75		0.75		0.65		0.55		0.55		0.50		0.50		AC: C

$\alpha_s$  = Sound absorption level

$\alpha_p$  = Practical sound absorption level

$\alpha_w$  = Evaluated sound absorption level

Additive (M) Better absorption in the medium frequency range (500 or 1000 Hz)

Additive (L) Better absorption in the low frequency range (250 Hz)

Additive (LM) Better absorption in the medium and low frequency range

**AC = Absorber Class**

B...Very highly absorbent

C...Highly absorbent

D...Absorbent

E...Low absorbency

Note: Acoustic values for F06 and F12 on request.



## ENJOY THE COMFORT & SAVE ENERGY

That's why our customers love us:

Heating and cooling optimised for COMFORT in all rooms!

Fast and friendly service, ANSWERS backed up with expertise!

Always in tune with the latest technology, INNOVATION guaranteed!

Everything CLEAR and SIMPLE, in writing of course!

PROFESSIONALISM at all times, from the first contact to the reference list!

## VARIOTHERM SINCE 1979

Variotherm is an Austrian model plant with hundreds of partners in Austria, Europe and around the world.

All rights pertaining to distribution and translation, in whole or in part, including film, radio, television, video recording, Internet, photocopying and reprinting, are reserved. Subject to mistakes and printing errors. Misprints and errors excepted.



Austria's  
Leading  
Companies  
2014



MCCH

VARIOTHERM HEIZSYSTEME GMBH

GÜNSELSDORFER STRASSE 3A

2544 LEOBERSDORF

AUSTRIA

Phone: 0043 22 56 - 648 70-0

Fax: 0043 22 56 - 648 70-9

office@variotherm.com www.variotherm.com